

ELECTRIC SCOOTER USER MANUAL

MODEL NO: HT-HVD-1/HT-HVD-3



Thank you for your choice, please read this manual before using this product.

V2022.0.1

CONTENTS

PACKAGE CONTENTS.....	01
PRODUCT OVERVIEW.....	02~09
CHARGE YOUR SCOOTER.....	10
HOW TO RIDE.....	11~12
FOLDING AND CARRYING.....	13
SPECIFICATIONS & WARRANTY.....	14~15
SAFETY INSTRUCTIONS.....	16~19
SAFETY REMINDER.....	20~21
DAILY CARE AND MAINTENANCE.....	22~23

PACKAGE CONTENTS

Assembled electric scooter

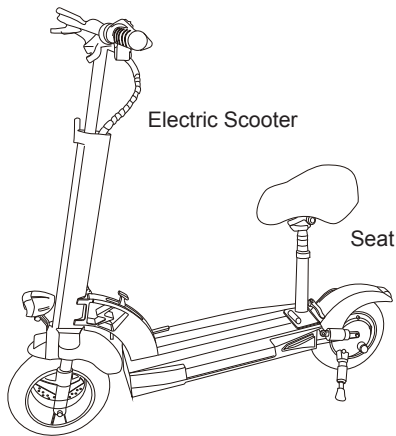

Accessories:

Charging adapter



Toolkit

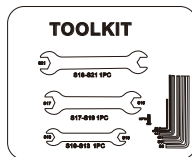

User Manual

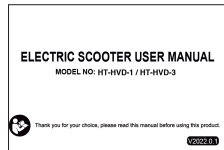

Carefully check package contents, if anything is missing or damaged, please contact our customer service for support

PRODUCT OVERVIEW



POWER SWITCH

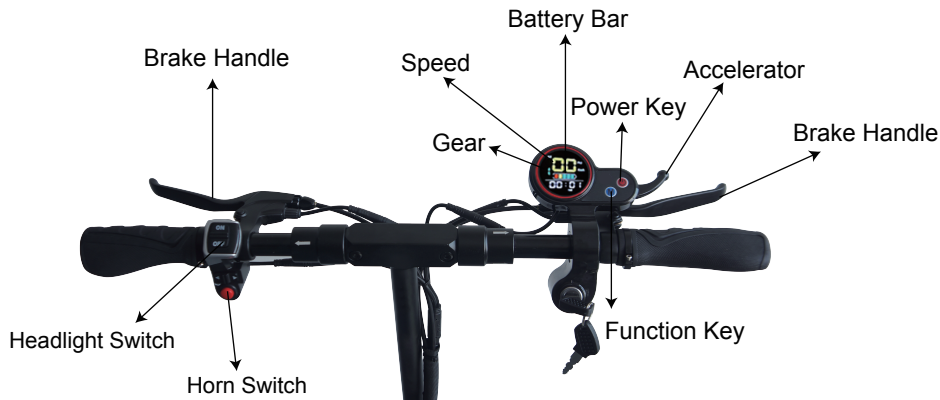

Press the accelerator lightly to speed up the electric scooter.

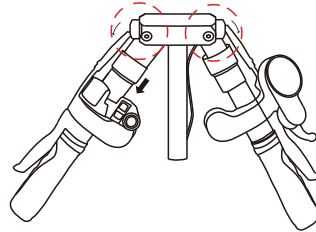
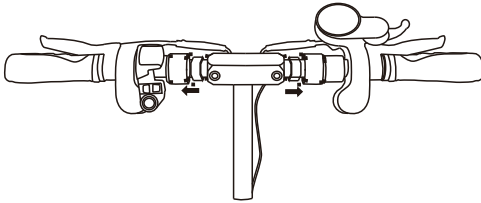

Warm reminder: To make folding more convenient, the ferrule and shaft are not fully tightened, it is normal if there is a gap. Please be assured that this will not affect driving safety.

If necessary, you can adjust it by yourself: adjusting the screw clockwise will loosen the handle, adjusting the screw counterclockwise will tighten the handle.

LCD-JX168 INTELLIGENT SPEED CONTROL- HANDLE INSTRUCTIONS (SPECIAL FOR SCOOTER)

Version Number: 2016020

Model Number: JX-168

Working Voltage: 8-80V

Function:

1.Display function

Speed Display, Battery Indicator, Fault Indicator, Headlight Indicator, Cruise Indicator, Gear Indicator, Total Mileage, Single Mileage, Real-time Voltage, Operating Current, Operating Time, Start Mode

2.Communication Protocol: UART

3.All display will be displayed within 1S after power on

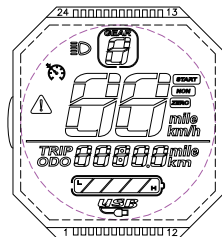

Icon Display Introduction

1. Battery Bar

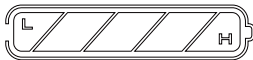

2. Multifunction Icon

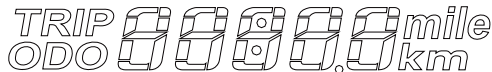

Total Mileage ODO; Single Mileage TRIP; Real-time Voltage V; Running Current A; Running Time TIME; Fault Code E

3. When the symbol  is flashing, short press the ON/OFF button to adjust the display interface to Fault Code E interface.

The corresponding number represents different fault, the details are as follows:

ERRO 1. Motor HALL Malfunction

ERRO 2. Brake Malfunction

ERRO 6. Low Voltage

ERRO 7. Motor Malfunction

ERRO 8. Handlebar Malfunction

ERRO 9. Controller Malfunction

ERRO 10. Receive time out

ERRO 11. Sending Failure

4. Speed Icon MPH, KM/H



5. Gear Icon

Short press the MODE button to switch the gears cyclically.

The higher the gear, the faster the speed. (The motor will not run at gear 0.)



6. Cruise Icon



After the motor is running, keep the speed for 5 seconds and then the cruise indicator lights up. After releasing the speed control handle, the motor keeps running at the original speed. When you brake or accelerate again, the cruise mode will end.

7. Start Method

Non-zero Start: NON indicator lights up

Zero Start: ZERO indicator lights up

START

NON

ZERO

8.USB Charging Icon



When USB is connected and generated exceed 100 mA current, the USB icon lights up. The icon flashing indicates intermittent charging or the load current exceeds 500mA, at this time it will automatically turn on the protection mode.

9. Parameter Setting and Definition

P02: Mileage Unit, 0: Km; 1: Mile;

P04: Sleep Time, 0: no sleep; Other Numbers: sleep time; Range, 1-60 minute;

P09: Zero Start, Non-zero Start, 0: zero start; 1: non-zero start;

P16: Real-time Cruise: 1: with this function; 0: without this function;

P99: One-key Reset, (long press the MODE button for 5-6 seconds, all parameters are reset to the initial settings of the first start)

ODO: ODO Reset (short press the MODE button and then long press for 5-6 seconds until the number is zero)

Brief Introduction of Key Functions

2.1 Long press the power button to power on, and then short press the power button, the interface will switch between ODO, TRIP, V, A, E, TM.

2.2 Long press the power button to power off.

2.3 Long press the M button and the power button to enter the mode setting. In the setting interface, short press the power button to switch parameters.

Short press the M button to change the speed, the gear shifts from 0 to the highest gear cyclically. (The gears default to 3 gears, 0 gear motor will not run, 3 gears is highest speed.)

Parameter Modification:

Long press the power button and M button to enter the parameter setting, the same way to exit the parameter setting. The parameter modification will be completed after power off and restart.

2.4 Adjust the accelerator to speed up; Release it to return to the zero position.

2.5 The headlight switch button controls the headlights and rear taillights, long press the M button for 3 seconds to control the side lights of the pedal.

CHARGE YOUR SCOOTER

Charging condition description:

The scooter is fully charged when the LED on the charger changes from red to green

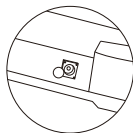
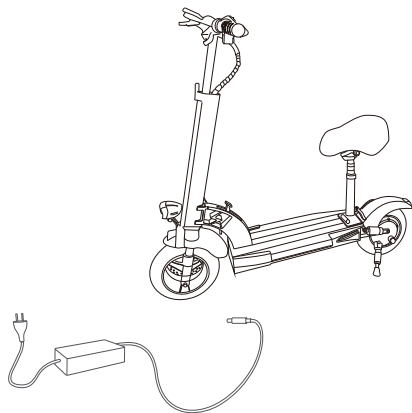

Lift up the rubber flap

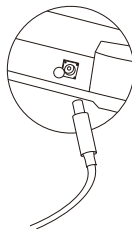

Plug the charging adapter into the charging port

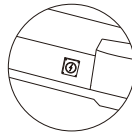

When charging is completed, put back the rubber flap

HOW TO RIDE

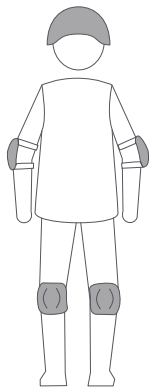

Warning: Wear a helmet, elbow pads and knee pads. Please read the instruction carefully before using. Do not touch the brake system. Refer to the instruction for more information

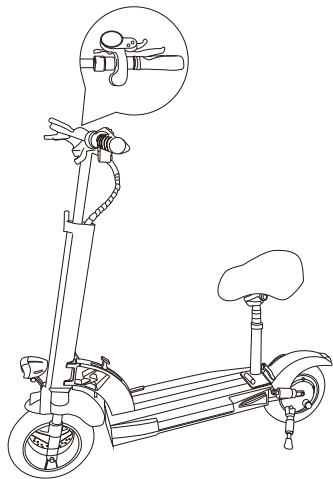

1, Turn on the scooter, and check the power indicator

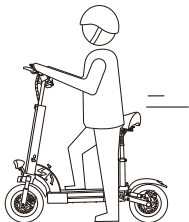

2, Step on the deck with one foot, and slowly kicks off the other on the ground. When the scooter starts to coast, put both feet on the deck and press the accelerator (the accelerator initiates once the coasting speed exceeds 5km/h)

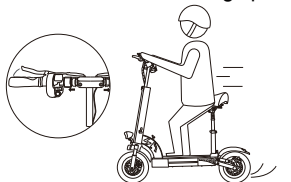

4, Release the accelerator and the kinetic energy recovery system initiates automatically to brake slowly; And squeeze the brake lever for a sudden brake

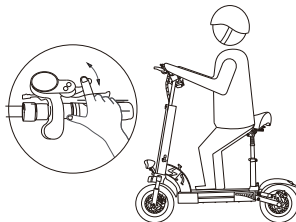

3, When the scooter is at a full stop, the accelerator automatically turns off. To restart the scooter, it is necessary to repeat step 2

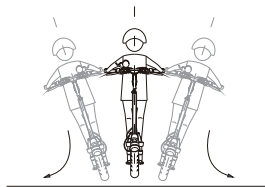

5, Tilt your body to the steering direction as you turn, and slowly turn the handlebar

FOLDING AND CARRYING

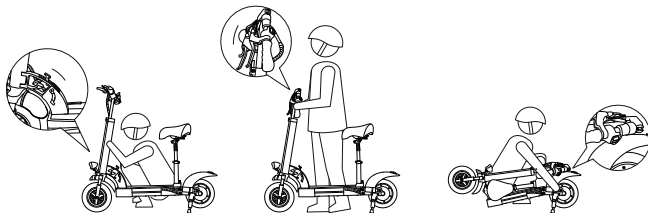

The scooter needs to be turned off before folding. Hold the handlebar stem, controlled by the folder device.

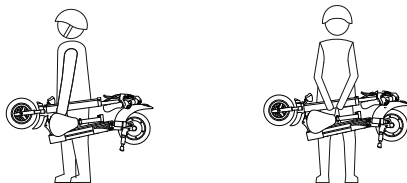

Hold the handlebar stem with either one hand or both hands to carry.

SPECIFICATIONS & WARRANTY

Product Name:	HT-HVD-1/HT-HVD-3
Package Dimension:	1130*290*405MM
Motor Power:	36V500W
	48V500W /800W/1000W
Battery Capacity:	36V08A/10A/13A/15A /48V10A/13A/15A/18A
Motor Type:	Strong Brushless Motor
Tire Type:	10" Solid Tires
N.W	23.6KG
G.W	27.8KG
Charging Time:	4-7H
Brake Type:	Front & Rear Disc Brake
Maximum Speed:	40-50KM, 1-3 gears switching
Maximum Mileage:	45-55KM

SPECIFICATIONS & WARRANTY

Storage Temperature:	1 month: -20 - 60 °C 3 months:-20 - 45 °C 1 year: -20 - 20 °C
Battery	Lithium-ion battery
Working Temperature	-10 ~ 40 °C
Charging Temperature	10 ~ 40 °C
Relative Humidity of Storage	5% ~ 95%

Note: data and specifications may vary due to different models, and are subject to change without notice.

Safety Instructions

Watch out for safety risks



Do not ride in the rain

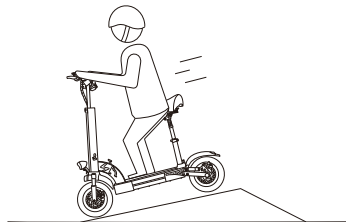

Do not accelerate when you go downhill

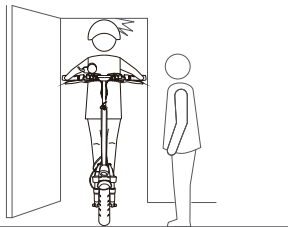

Look out for doors, elevators and other overhead obstacles

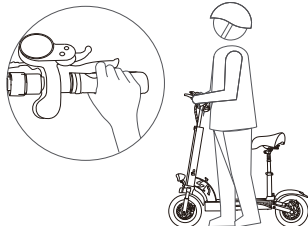

Do not press the accelerator when you're walking alongside the scooter



Always steer clear of obstacles

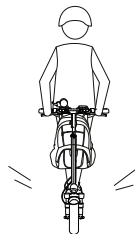

Do not hang bags or other heavy stuff on the handlebar

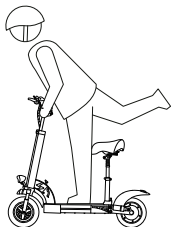

Keep both feet on the deck all time



Keep your speed between 5–10 km/h when you ride through speed bumps, elevator door stills, bumpy roads or other uneven surfaces. Slightly bend your knee to better adjust mentioned surfaces

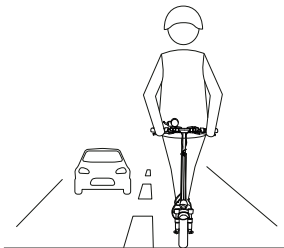

Do not ride in traffic lanes or residential areas where vehicles and Pedestrians are both allowed

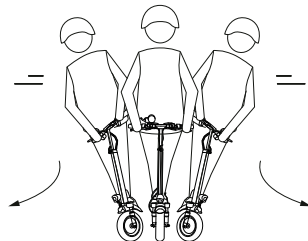

Do not turn the handlebar violently during high-speed riding



Do not ride through puddles or any other (water) obstacle. In such a case please lower your speed and bypass the obstacle.

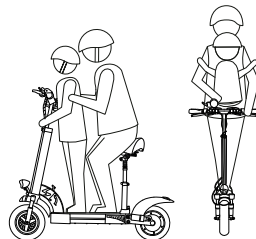

Do not ride with anyone else, including children

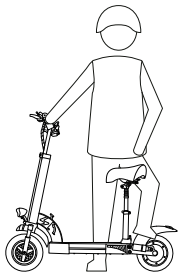

 Do not keep your feet on the rear mudguard

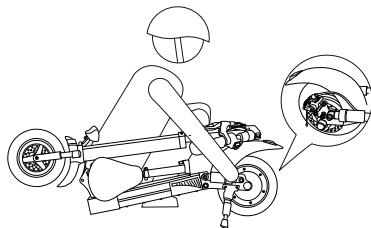

 Do not touch the disc brake

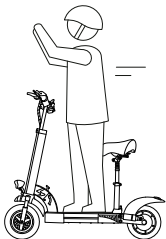

 Do not keep your hands away from handlebar

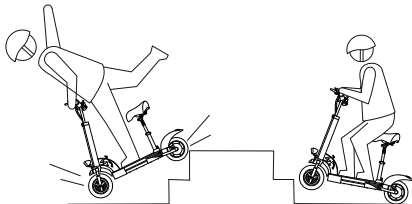

 Do not try riding up or down stairs, and jumping over obstacles

Safety Reminder!

- 1.The scooter is intended for riders older than 16 years. Do not ride the scooter if you suffer from reduced physical, sensorial or mental capabilities. Riders with a lack of experience or knowledge should drive carefully.
- 2.This electric scooter is a leisure device. But once they're in a public area, they'll be seen as vehicles, subjecting to any risks faced by vehicles. For your safety, please follow instructions in the manual and traffic laws and regulations set forth by government and regulatory agencies.
- 3.At the same time, you should understand that risks cannot be entirely avoided as others may violate traffic regulations and drive incautiously, The faster the scooter is, the longer it takes to stop. On a smooth surface, the scooter may slip, lose balance, and even result in a fall. Thus it is crucial that you use caution, keep proper speed and distance, especially so when you're unfamiliar with the place.
- 4.Riding with high speed or a speed that is not appropriate or adequate for the situation (bad weather conditions, bad surface conditions, or the like) may lead into a potential loss of stability or loss of control. To reduce any risk, you must follow all instructions in this user manual. Be careful when folding and unfolding the product, it may fall and cause injury.

5. Check the scooter before every use. When you note loose parts, low battery alerts, flat tires, excessive wear, strange sounds, malfunctions and other abnormal conditions, stop riding immediately and call for professional support.

6. When riding a scooter, you need to hold the handle with both hands to avoid shaking and falling down.

7. Always place the scooter on its stand on a flat and stable surface. The scooter must be placed with the stand against the slope to prevent it from tipping over. Never place the scooter with the front facing down the slope, as the stand may close and tip the machine.

DAILY CARE AND MAINTENANCE

Cleaning and storage

If you see stains on the scooter's body, wipe them off with a damp cloth. If the stains won't scrub off, put on some toothpaste, and brush them with a toothbrush, then wipe them off with a damp cloth. If you see scratches on plastic parts, use sandpaper or other abrasive materials to polish them.

Notes:

Do not clean the scooter with alcohol, gasoline, kerosene or other corrosive and volatile chemical solvents to prevent dire damage.

Do not wash the scooter with a high-pressure water spray.

During cleaning, make sure that the scooter's turned off, the charging cable is unplugged, and the rubber flap is closed as water leakage may result in electric shock or other major problems.

When the scooter's not in use, keep it indoors where it is dry and cool. Do not put it outdoors for long time. Excessive sunlight, overheating and overcooling accelerate tire aging and compromise the scooter and the battery pack's lifespan.

Maintenance:

Always charge before exhausting the battery to prolong the battery's lifespan. The battery pack performs better at normal temperature, and poor when it is below 0°C. For instance, when it is below -20°C, the riding range is only half or less at normal state.

When the temperature rises, the riding range restores.

Scooter shall be only be used with original batteries and charging of the Scooter shall only be done by the original charging adapter supplied with the Scooter (or any battery model or charging adapter model approved by the manufacturer as compatible).

Do not place the battery in an environment where the ambient temperature is higher than 50°C or lower than -20°C (e.g., do not leave the scooter or the battery pack in a car under direct sunlight for an extended time).

If the scooter is expected to be left idle for more than 30 days, please fully charge the battery and place it in a dry and cool place. Keep in mind to recharge it every 60 days to protect the battery from potential damage which is beyond limited warranty.

