



# DYU SMART ELECTRIC BIKE STROLL 1 INSTRUCTION

Do Not Use This Product Without Carefully Reading This Instruction Manual and Understanding The Performance Of Electric Bicycles please Keep The Instruction Manual Properly



Multilingual version

<https://dyucycle.com>

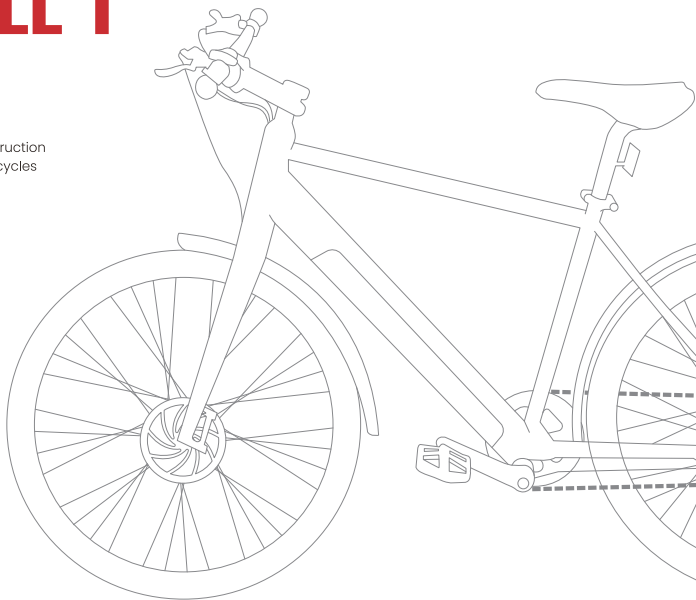



**Discover Your Uncharted Ride**

# TABLE OF CONTENTS

**02**

**Parts & Components**

**05-16**

**1. Assembly**

- 1.1 Mudguard
- 1.2 Front Tire
- 1.3 Handlebar
- 1.4 Seat
- 1.5 Pedals
- 1.6 Battery
- 1.7 Tires

**04**

**Warranty Statement**

**17-21**

**2. Functions**

- 2.1 Kickstand
- 2.2 Brake
- 2.3 Riding Modes

**22-28**

**3. Display**

- 3.1 General
- 3.2 Display When Riding
- 3.3 How to Operate
- 3.4 User Setting (& Properties View)
- 3.5 Error Alert

**30-31**

**5. Riding Safety**

**36-39**

**Specification**

**41**

**Disclaimer**

**29**

**4. Derailleur System**

**32-35**

**6. Storage & Maintenance**

- 6.1 Storage
- 6.2 Maintenance

**40**

**Trademark**

**42-43**

**Contact us  
Installation Guide**

# Parts & Components

- |                     |                            |                             |
|---------------------|----------------------------|-----------------------------|
| 1. Left Brake Lever | 12. Disc Brake Rotor       | 23. Kickstand               |
| 2. Bell             | 13. Wheel Reflector        | 24. Motor                   |
| 3. Mechanic Shifter | 14. Disc Brake Caliper     | 25. Rear Derailleur         |
| 4. Headlight        | 15. Front Mudguard Support | 26. Spoke                   |
| 5. Display          | 16. Front Mudguard         | 27. Rear Mudguard           |
| 6. Grip Cover       | 17. Battery                | 28. Seat Tube Quick Release |
| 7. Handlebar        | 18. Frame                  | 29. Seat Tube               |
| 8. Head Reflector   | 19. Pedal                  | 30. Rear Reflector          |
| 9. Front Fork       | 20. Crank                  | 31. Saddle                  |
| 10. Tire            | 21. Chain Wheel            |                             |
| 11. Hub             | 22. Chain                  |                             |

## Tools and accessories include:



one multifunctional  
spanner



one pair of  
pedals



one battery



one charger  
with cable



one warranty  
card



and one  
owner's  
manual



Kettle Holder

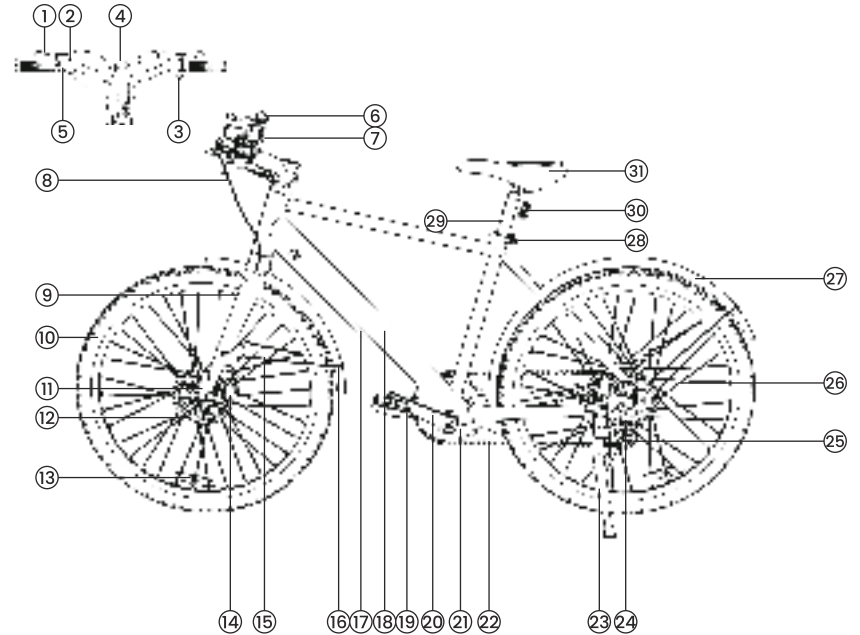

NOTE: IMAGES MAY NOT REFLECT EXACT APPEARANCE OF ACTUAL PRODUCT

# Warranty Statement

Should the product you purchased comes with missing or damaged parts or functions (within the scope of warranty), DYU shall provide you with repair and replacement service within the specified period of warranty (which can be tracked by the order number on the DYU official website, or by the proof of purchase that can be obtained from the retailer).



Please note that the warranty applies to purchase from the DYU official website or designated retailer only. DYU shall not provide the repair and replacement service to any produce purchased from elsewhere.

**For details, please visit:**

<https://dyucycle.com/pages/warranty>

# 1. Assembly

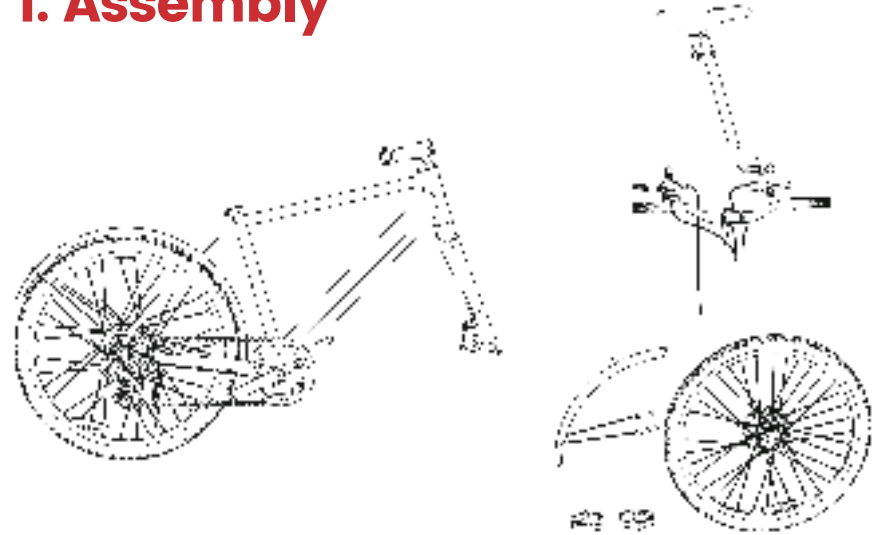

Product taken out of the box

Parts to be assembled: Handlebar, Left and Right Brake Levers, Mechanic Shifter, Front Wheel, Front Mudguard, Pedals, and Seat.  
 Demonstration video can be accessed via the QR code on the eBike.

## 1.1 Mudguard

Align the mudguard support with the dropouts of the front fork. Fasten the screws on the mudguard, and then those on the mudguard support.

1. Take out your eBike, and unfold.
2. To align the front and rear of the frame in a straight line, press the frame quick release.
3. Wait till the frame straightens up. A sound of click indicates that the frame connection is firm.

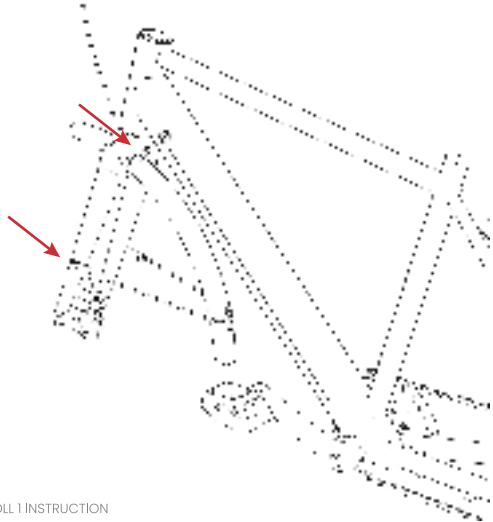

## 1.2 Front Tire

### I. Basic mechanical principle with the quick release lever

Turn the adjusting nut clockwise to increase clamping, and counter-clockwise to decrease.

**For the quick release lever to be in the CLOSE position, turn the adjusting nut clockwise. As the nut screws inwards, the wheel is clamped onto the frame and locked into the correct position.**

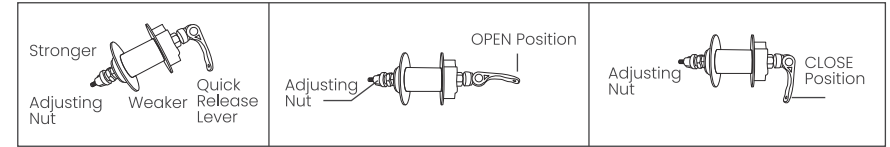

### II. How to install

1. Open the quick release lever, and insert the front wheel **all** the way into the dropouts of the front fork.

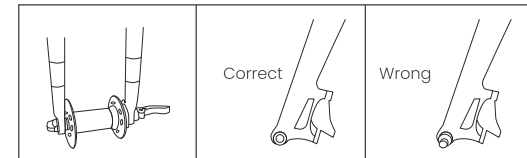

2. With your left hand, turn the adjusting nut clockwise to fasten up, and with your right hand, close the quick release lever. Continue to turn the adjusting nut **till** the lever runs **parallel** to the hub (as indicated below) and resistance from the lever is felt.

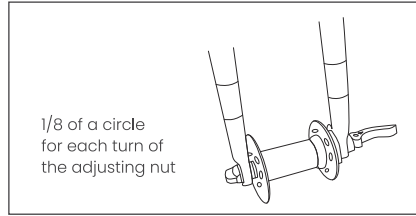

3. Hold the legs of the front fork with your fingers, and use your palm to press on the quick release lever to lock into place. The **CLOSE** mark should face outwards, and the lever should be ahead of the legs or parallel to them (as indicated below).

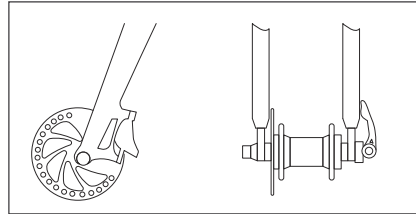

## Assembling the Front Wheel

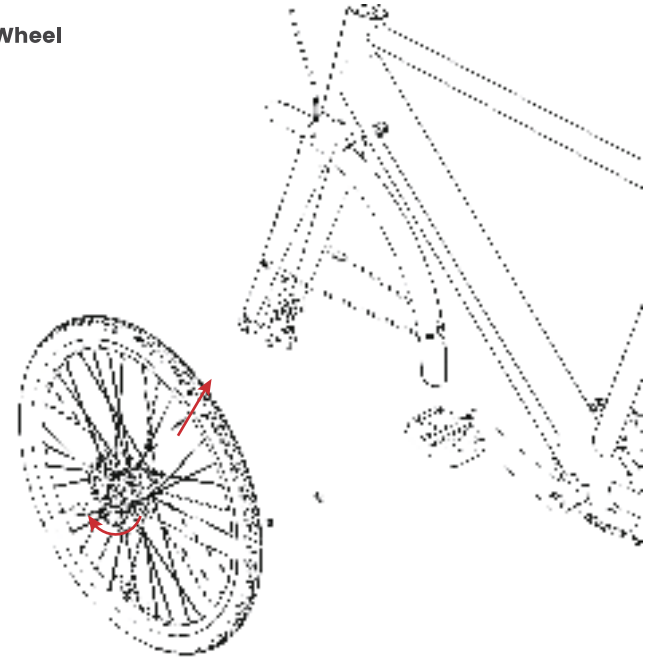

### 1.3 Handlebar

#### How to Assemble

1. Loosen the screws on both sides of the stem and also those on the top. Turn the stem to face forward.

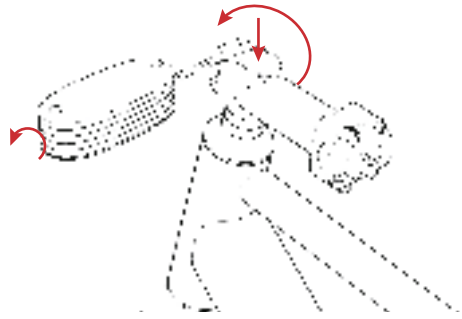

2. Align the stem properly, and fasten the screws on the top and sides.



3. Open the clamp on the front, and insert the handlebar. Remove the grip cover, and assemble the parts as indicated. Lastly, attach the grip cover and fasten the screws.

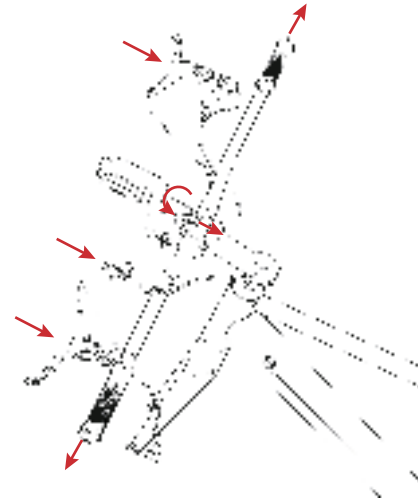

Lastly, attach the grip cover and fasten the screws.

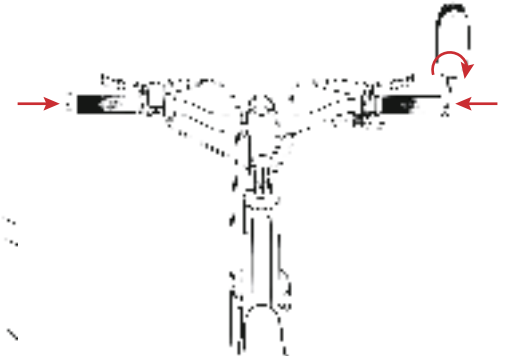



## 1.4 Seat

### How to assemble

1. Loosen the seat tube clamp.
2. Insert the seat tube into the frame.  
Adjust the seat tube to desired height, but never go below the minimum mark. Tighten the nut and close the clamp.



3. Push the seat left and right to confirm the stability. If rotation occurs, please turn the nut clockwise for half a circle, close the clamp, and check again.



## 1.5 Pedals

### How to assemble

1. Insert the pedal marked "R" into the crank.
2. Hold the pedal with your hand, and turn it clockwise for a few rounds. Then clamp the pedal shaft with the spanner in the package, and turn it clockwise until fastened.
3. Find the L pedal and repeat the above steps (but rotate counterclockwise).
4. If you feel resistance when turning the pedal shaft, immediately remove the pedal to avoid possible damage. Attach the pedal again and make sure the pedal shaft is perpendicular to the threaded hole on the crank. Proceed with the rest of the steps.

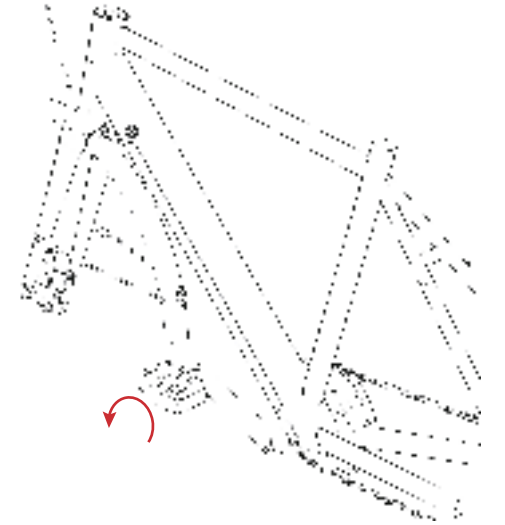

## 1.6 Battery

### Remove the battery

Turn the battery key counterclockwise to unlock, and the battery shall pop up.

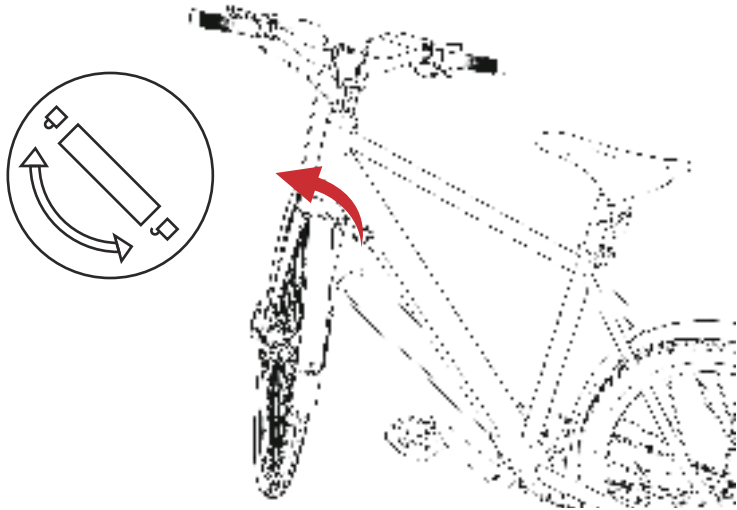

### Charge the battery

The battery can be charged via the charging port on the frame (when battery stays inside the frame) or on the battery (after battery is removed from the frame).

1. When battery stays inside the frame, ensure normal connection of the battery first.
2. Connect the charging cable with the charger, and then to the charging port on the frame.
3. Plug the charger to the mains to start charging. When the charging indicator light is red, the battery is charging. When the light turns green, the charge is complete. A full charge takes 6–7 hours. Disconnect the charger after charging.
4. Close the charging port cover.

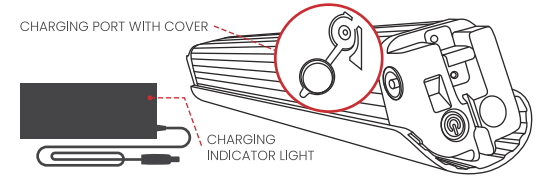

#### CHARGING INDICATOR LIGHT ON THE CHARGER

- CHARGING
- CHARGING COMPLETE

To charge the battery away from the frame, remove the battery first.

#### ATTENTION

1. Please use the charger from the package.
2. Please keep the charging port cover closed when not charging.
3. Do not switch on the battery while charging.
4. To preserve battery life, always charge the battery fully.
5. Unplug the charger immediately when the indicator light turns green.
6. Do not disassemble the battery.

## 1.7 Tires

Before every ride, check the tires for proper tire pressure.

### Inflate the tires

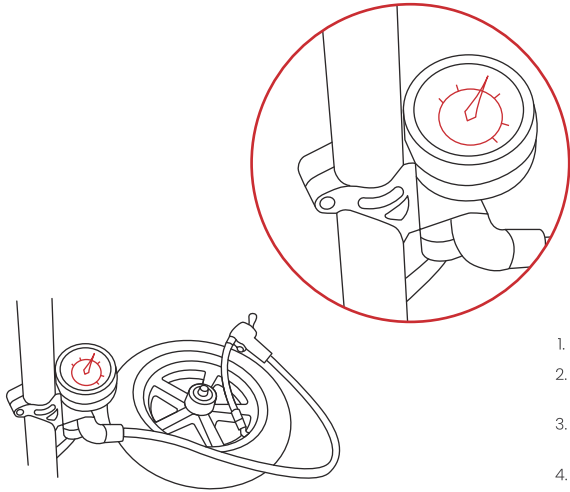

1. Unscrew the valve cap counterclockwise.
2. Clip the pump on the valve, and start pumping. Each push should be even.
3. Stop pumping when there is enough tire pressure, and detach the pump.
4. Screw the valve cap back clockwise.

## 2. Functions

### Handlebar

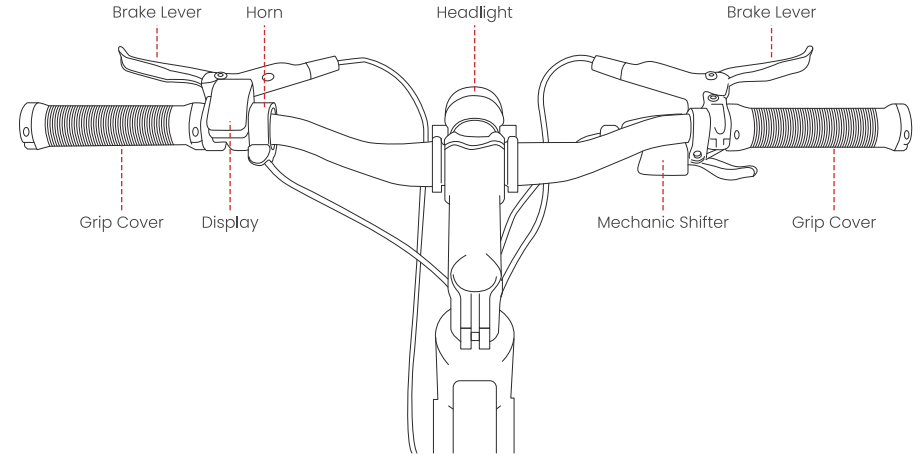

## 2.1 Kickstand

### How to assemble

Align the kickstand with the correct screw holes on the frame, and fasten the screws to secure.

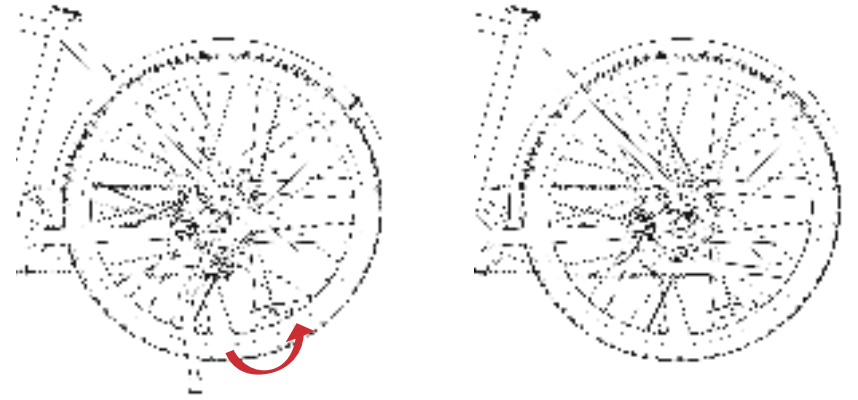

1. Kick the kickstand backward with your foot, and it shall lift up to a position parallel to the ground.
2. Gently press down the kickstand towards the ground with your foot, and it shall support the eBike against the ground.

**Note: Please be sure to swing the kickstand up before riding.**



## 2.1 Brake

### Brake control

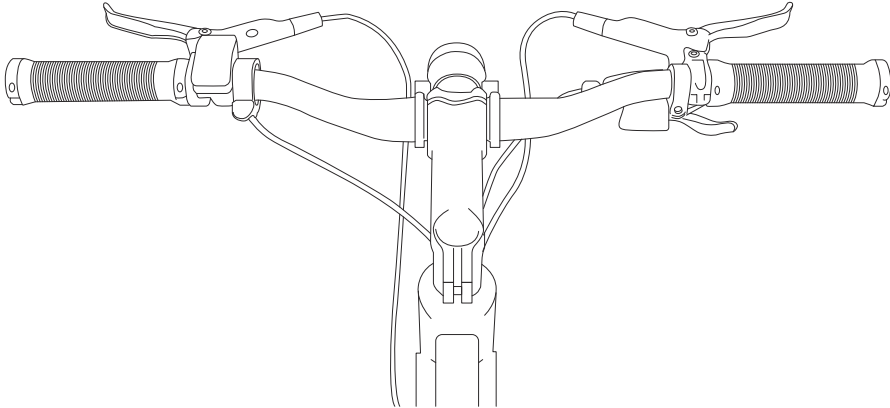
The left brake controls the rear wheel, and the right brake controls the front wheel.



## 2.3 Riding Modes

 <b>Sport</b>	<p>Power is off and there is no motor output. Pedal and exercise.</p>		 <b>Pedal Assist</b>	<p>When the power is on, and while you are pedaling, the motor also provides power for an easier and more energy-efficient ride.</p>
---	---	--	--	--

**Note:** When your pedaling speed exceeds the maximum speed that the motor provides, the motor is not engaged regardless of the riding mode.

# 3. Display

## 3.1 General

1. Four buttons for easy operation
2. Real-time speed
3. Four gears from 0 to 3
4. Battery level in five bars, plus under-voltage alert
5. Pedal Assist
6. Headlight status (if supported by controller)
7. Error code

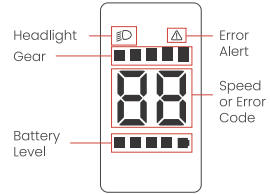

### Display upon power-on

All icons and segments swiftly light up one by one, and then flash altogether twice.

## 3.2 Display When Riding

1. Gear from 0 to 3
2. Real-time speed
3. Battery level in five bars, plus under-voltage alert (flashing icon)



### Buttons

-  : Power
- M** : Function
- Adjustment +: Upper part of the interface ( ^ )
- Adjustment -: Lower part of the interface ( v )

### 3.3 How to Operate

#### 1.Power On/Off

Ensure normal connection of the display and the controller first. Press and hold the power button for two seconds to turn on or off the display. The display powers off automatically after ten minutes (default) of inactivity when the speed is zero.

#### 2.Gear

Press or to shift among four gears: 0-1-2-3.

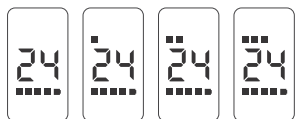

Gear 0 Gear 1 Gear 2 Gear 3

#### 3.Pedal Assist

Press and hold to activate Pedal Assist.  
Release to exit.

#### 4.Headlight (& Display Brightness)

Press and hold to switch on or off the headlight.  
The brightness of the display lowers when the headlight is on, and normalises when it is off.



Headlight off  
(high brightness)



Headlight on  
(low brightness)

#### 5.Battery level

The battery level is indicated in five LCD bars as below. When the battery is exhausted or nearly, zero bar is shown and the contour of the battery icon flashes. Please charge the battery immediately.

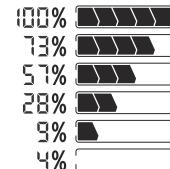

Details on the display of battery level in state of charge (C) (which may be customized)

No.	Battery Level (SOC)	Display	Voltage (24V)	Voltage (36V)	Voltage (48V)
1	C≤5%	Flashing icon	U≤23.1	U≤33	U≤42.9
2	5%<C<15%	One bar	23.1<U<24.5	33<U<34.7	42.9<U<45.1
3	15%≤C<35%	Two bars	24.5≤U<25.1	34.7≤U<35.8	45.1≤U<46.5
4	35%≤C<55%	Three bars	25.1≤U<25.6	35.8≤U<36.7	46.5≤U<47.5
5	55%≤C<75%	Four bars	25.6≤U<27	36.7≤U<38.5	47.5≤U<50.1
6	C≥75%	Five bars	U≥27	U≥38.5	U≥50.1

## 3.4 User Setting (& Properties View)

In the User Setting mode, the unit of measurement may be changed, and eBike properties including the wheel size, maximum speed, and battery voltage may be viewed.

### 1. Enter User Setting

- Within ten seconds after turning on the display, press and hold the **M** button for two seconds to enter User Setting to change the unit system or view the properties.
- To save the setting and exit User Setting, press and hold the **M** button for two seconds again.
- Ten seconds of inactivity shall automatically deactivate the setting mode without saving any setting and resume normal display.
- In the User Setting mode, tap **^** and **v** to shift among items.

### 2. Change the unit system

In the User Setting mode, when the first bar of Gear flashes and the fifth bar stays lit, you may view and change the unit system. The default setting is metric (KM). You may change it to the imperial system (M). The display adopts the 7-segment LED standard alphabet.



Metric (KM)



Imperial (MI)

### 3. View the wheel size

In the User Setting mode, tap **^** and **v** to shift among items. When the second bar of Gear flashes and the fifth bar stays lit, you may view the wheel size. For example, 700C is displayed as 7c, and 27.5 is displayed as 27.



26inch



700C

### 4. View the maximum speed

In the User Setting mode, tap **^** and **v** to shift among items. When the third bar of Gear flashes and the fifth bar stays lit, you may view the maximum speed which by default is 25 km/h (or 15.53 mph).



default is 25 km/h

### 5. View the battery voltage

In the User Setting mode, tap **^** and **v** to shift among items. When the third bar of Gear flashes and the fifth bar stays lit, you may view the battery voltage which is displayed in two digits with decimal rounded off.



voltage 36V



### 3.5 Error Alert

#### 1. Error alert

When there is an error or failure, the error alert icon lights up, and the error code flashes.



**Error 30**

#### 2. Error code

The error code is obtained from the controller order. Typically, the controller defines the error codes. Currently only ERROR 30 for communication failure is defined

Error Code	Definition	Troubleshooting
E30	Communication failure: Display fails to receive data from the controller or the data received is erroneous.	<ol style="list-style-type: none"> <li>1. Check if the connection with the TX and RX communication cables is correct.</li> <li>2. Check if any cable or connector is loose or broken.</li> <li>3. Check if the display communication protocol is matching.</li> </ol>

Failure Code	Failure Status
06	Battery Under-voltage
07	Motor Failure
08	Throttle Failure
09	Controller Failure

Failure Code	Failure Status
10	Controller Receiving Failure
11	Controller Transmitting Failure
14	Hall Sensor Abnormal

## 4. Derailleur System

### Derailleur system

The derailleur system includes the front and rear derailleur, the shift levers, and the derailleur control cables, all of which must function properly for smooth gearshifting to occur.

#### Derailleur

Although the front and rear derailleur are initially adjusted in our factory, you will need to inspect and readjust just both before riding bicycle.

#### Rear Derailleur

Begin by shifting the rear swifter to largest number indicated, loosen the cable from the rear derailleur cable anchor bolt, and place the chain on the smallest sprocket.

Adjust the high limit screw so that the guide pulley and the smallest sprocket are lined up vertically. Re-tighten the cable, pull out any slack, and re-tighten the anchor bolt securely. Shifting through the gears, making sure that each gear is achieved quietly and without hesitation. If necessary, use the barrel adjuster to fine tune the cable tension by turning it the direction you want the chain to go. For example, turning clockwise will loose the cable tension and move the chain away from the wheel, while turning counter-clockwise will tighten cable tension and direct the chain to the wheel.

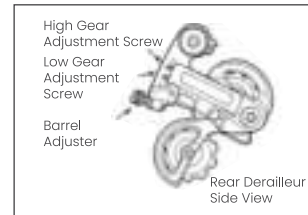
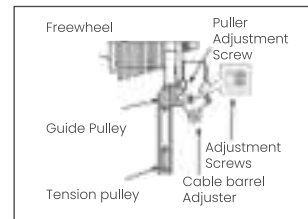

## 5. Riding Safety

### ATTENTION

Always keep your feet on the pedals when riding, whether you need to pedal or not. Riding with your feet dragging on the ground is strictly prohibited.

The maximum speed in each ride may vary, depending on the weather, riding behavior, load, and many other factors. For the test conditions of rated maximum speed, please refer to the Specification toward the end of this manual.



Please note that in case of any violation of laws in your region or the requirements in this manual, DYU shall not be responsible for any resulting product damage, personal, mental or property damage, and related dispute.

### NOTES

Although this product is a means of transportation for leisure and entertainment, once it enters the transportation system, it shall be regarded as a motor vehicle with legal rights and responsibilities. Please be sure to learn and understand the local traffic laws before riding.

Please apply common knowledge on traffic. The faster you ride, the longer the braking time and distance which respectively multiplies. While traffic conditions are ever-changing, ride at a safe and slow speed to prevent accidents caused by others. When you are behind pedestrians, please ring the bell but do not startle them (especially children). Remember to slow down when passing a crosswalk to minimize danger.

Before lending this product, please make sure that the borrower is aware of the content in this manual and all applicable laws. The borrower shall have a helmet and other protective equipment ready to wear.

Before each ride, please check for any loose part and abnormal sound. Also check battery level, tire pressure, and the display. In the event of any abnormality, please do not insist on riding but contact customer service on DYU official website immediately for help.

### Weather and terrain

1. When riding in rain or snow, the braking distance shall be extended, so please ride slowly. In severe weather such as heavy rain, avoid travelling.
2. Slow down when going downhill or on bumpy roads. On any non-motor vehicle lane, downhill and paved road, the speed shall not exceed 15 km/h (or 9.32 mph).

### Caution

1. Do not ride indoors.
2. Do not accelerate while walking your eBike.
3. Always keep your hands on the handlebar.
4. Do not swing wildly from side to side.
5. Please use fitting basket and seat (additional purchase) for carrying goods and passenger.

### Check before riding

1. The recommended tire pressure is 345–515 kpa.
2. The power circuit, lighting circuit, etc. should be normal.
3. The front and rear brakes should function normally. Pull the brakes and check if they can control the wheels tightly. The reflectors should not be damaged or soiled.
4. When adjusting the handlebar or saddle, be careful not to go beyond the safety marks.

### Speed limit



**The speed limit may vary in different regions. Please check your local laws and regulations before riding, and strictly abide by them.**

# 6. Storage & Maintenance

## 6.1 Storage

### 6.1.1 Indoor storage

Keep the eBike unfolded as a normal bike. Alternatively, fold the eBike and store it in a corner. Do not keep the battery connected to the mains while the eBike is in long storage, but charge the battery regularly to maintain battery life.

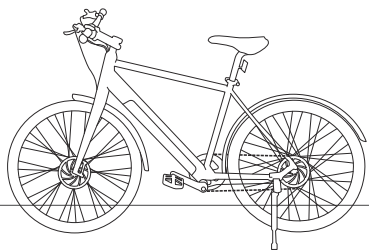

## 6.2 Maintenance

### 6.2.1 Cleaning

Never rinse the eBike. Wipe with a damp cloth to clean.

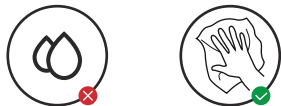

After riding, please store the car in a place without direct sunlight or rain.

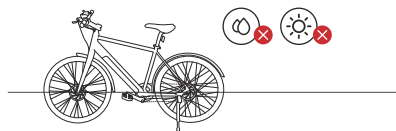

### 6.2.2 Regular inspection

#### When unpacking

Check all screws in case any is loosened. Reinforce them from time to time to keep them fastened.

Recommended torque: handlebar screw 60–80 kgf.cm (or 52.08–69.44 lbf.in), steering stem screw 175–200 kgf.cm (or 151.90–173.60 lbf.in), saddle screw 175–250 kgf.cm (or 151.90–217.00 lbf.in), and wheel screw 320–450 kgf.cm (or 277.70–390.60 lbf.in).

#### Regular inspection

Regularly check the tension of the chain, which can be adjusted via the chain regulator.

Check the motor and brake frequently. Do not oil the brake.

Always check the tires for scratches, cracks or excessive wear. The inner tube and valve must be perpendicular to the wheel hub at all times.

### 6.2.3 Replacement of parts

#### Tire replacement

Punctured, damaged or excessively worn inner tube and tire must be replaced immediately. For repairing and replacing your tire cover, please contact professional technicians. DYU does not provide replacement.

#### Modification is prohibited

It is forbidden to modify key structural parts including the frame, front fork and steerer tube, and any electrical parts. The warranty shall not apply to any part and component that is not original from DYU. The owner shall take sole responsibility for any loss or damage due to modification.

### 6.2.4 Battery and charging

#### Storage conditions

Never put the battery in acid or alkaline liquid. Keep away from rain, fire, heat and high temperature. Do not connect the positive to negative, or vice versa. Do not damage, disassemble, or short-circuit the battery.

When not in use, store the battery in a dry (relative humidity at 65±20%) and cool (temperature at 10-35°C, or 50-95°F) place. Make sure to charge the battery for two hours each month.

### Charge the battery

Use the original charger from the package to charge the battery. Do not disassemble the charger or replace parts and components in the charger on your own.

The charger must match with the battery type and applicable voltage. Never mix the use of different chargers.

Charge only in a well-ventilated area, away from sun and heat. Connect the charger and battery before plugging the charger into the mains.

When charging, if the charging indicator light appears abnormal, a smell is released, or the charger overheats, stop charging immediately. Service or replace the charger.

To stop charging, unplug from the mains before disconnecting the charger and battery. When the charging indicator turns green, stop charging. Do not leave the charger connected to any AC power source when not charging.

When in use or in storage, avoid water, other liquid, or other foreign matter inside the battery to prevent short circuit. It is advisable not to carry the charger with your eBike. If you must, place the charger in a toolbox upon shock absorption treatment.

### Recycle the battery



Waste battery is classified as hazardous. Do not disassemble the waste battery on your own. Please contact professional agency for its recycle.

# Specification

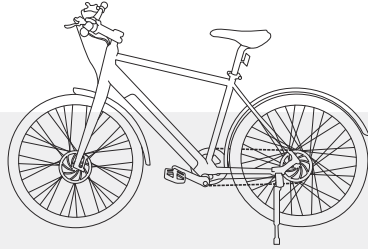

## Model: Stroll 1

<b>Packaging</b>	Packing size	1475*240*740 mm (or 58.07*9.45*29.13 in)
	Gross weight	25.5 kg (or 56.2lbs)
<b>General</b>	Expanded size	1830*635*1050 mm (or 72.05*25*41.33 in)
	Folded size	/
	Net weight	19.5 kg (or 42.99 lbs)
	Handlebar width	640 mm (or 25.20 in)
	Pedal ground clearance	100 mm (or 3.94 in)
	Max load	120 kg (or 264.55 lbs)
	IP rating	IP54
	Frame material	Aluminum alloy

<b>General</b>	Speed	15 km/h (or 9.32 mph)
		20 km/h (or 12.43 mph)
		25 km/h (or 15.53 mph)
	Brake system (disc brake/ electric brake/ drum brake / other to be specified)	Front: Oil disc
		Rear: Oil disc
	Hill climbing capacity	15 degrees
Max speed	25 km/h (or 15.53 mph)	
<b>Motor</b>	Type	High-speed motor
	Rated power	250W
	Standard voltage	36V
	Location (hub/ mid-drive/ other in-wheel)	Spoke motor
<b>Battery</b>	Type	Power lithium battery
	Capacity	9Ah
	Voltage	36V
	Charging time	6-7 hours

<b>Range</b>	Pedal Assist mode	65±2 km (or 40.39±1.24 mi)
<b>Headlight</b>	Type	LED
<b>Rear light</b>	Type	/
<b>Charging</b>	Input	AC 100-240V
	Output	42V/1.5A
<b>Tire</b>	Size	700×38C
	Type	Pneumatic
	Tire pressure	345-515 kpa
<b>Seat</b>	Min (height from ground)	900 mm (or 35.43 in)
	Max (height from ground)	1050 mm (or 41.34 in)
	Adjustable height	Yes
<b>Display</b>	<b>Type (LED/LCD/OLED)</b>	<b>LED</b>
<b>Application</b>	Smart application	/
<b>Features</b>	Cruising	/
	Choice of unit systems	Yes (KM/H by default)
	Speed limit removed	/
	Others	The eBike automatically powers off upon ten minutes of inactivity.



Note: The maximum speed may vary, depending on the battery level, load, tire pressure, terrain, lubrication state of the chain and bearings, etc. The ranges are determined upon tests at the ambient temperature of 25°C (or 77°F), at the speed of 15 to 20 km/h (or 9.32 to 12.43 mph), on smooth and firm terrain, with a load of 60 kg (or 132.30 lbs.), and within an uninterrupted period from full to zero battery level. The ranges may vary, depending on your riding behavior, ambient temperature, load, tire pressure, terrain, etc.

## Trademark

 is a registered trademark held by DYU Intelligent Mobility Technology Co., Ltd. The company is entitled to all rights pertaining to the trademark. "DYU eBike" is a trademark registered and used by Shenzhen DYU Intelligent Mobility Technology Co., Ltd. Only the branch(es) of the company upon authorization may use the trademark legally.

© 2023 Shenzhen DYU Intelligent Mobility Technology Co., Ltd. All rights reserved.

This manual is applicable to Model STROLL 1 only. The product functions of other models may vary due to technical iteration and design difference, so please refer to the actual product. If necessary, please scan the QR code at the end of this manual to get the latest information.

## Disclaimer

The company reserves the right of modification and final interpretation of the product model, specification or related information mentioned in this manual.

Any modification or change of the product model, specification or related information mentioned in this manual will not be notified.

Without the prior written permission of the company, the contents of this manual shall not be copied, modified, reproduced, disseminated or published in any form.

Please read this manual carefully before using the product, and operate in accordance with the instructions. Otherwise, the company will not be responsible for product damage or personal or property loss caused by improper use or mistakes.

## Contact us

 <https://www.facebook.com/DYUCYCLE>  
Facebook Group  
<https://www.facebook.com/groups/dyucycle>

 <https://www.youtube.com/@DYUcycle>

 <https://www.instagram.com/dyucycle>

 <https://dyucycle.com>



## Installation Guide



**Video link:** [https://youtu.be/5dNBM3lu4\\_0](https://youtu.be/5dNBM3lu4_0)





<https://dyucycle.com>

**Manufacturer:** Shenzhen DYU Intelligent Mobility Technology Co., Ltd

**Factory:** DYU (Huizhou) Smart Transport Technology Co., Ltd.

**Factory Address:** Factory Block 1, Sanxu Village Committee and Meihua Village Committee, Luoyang Neighborhood, Boluo County, Huizhou City, Guangdong Province

**Telephone:** 400-080-7170