

**DUALTRON**  
**TOGO**  
Personal Mobility  
**PRODUCT MANUAL**

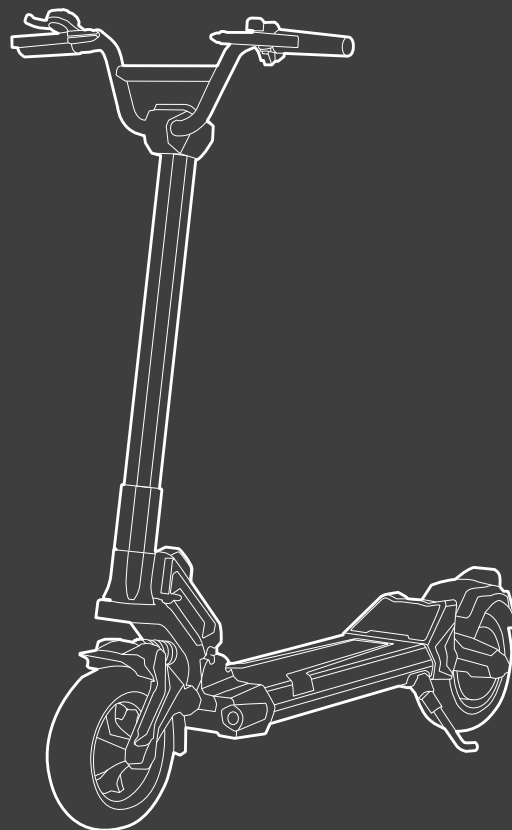

Model No. : AD2309



Scan the QR code to download the latest user materials  
and obtain the latest updates and safety instructions.

# DUALTRON

The dream of electric technology.

Pictures for reference only, subject to our existing products.

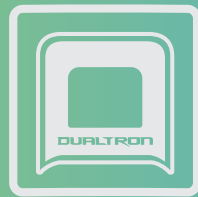



*MINIMOTORS*

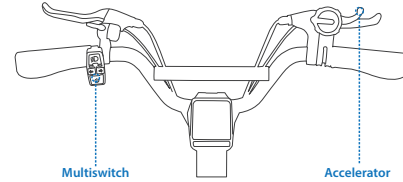
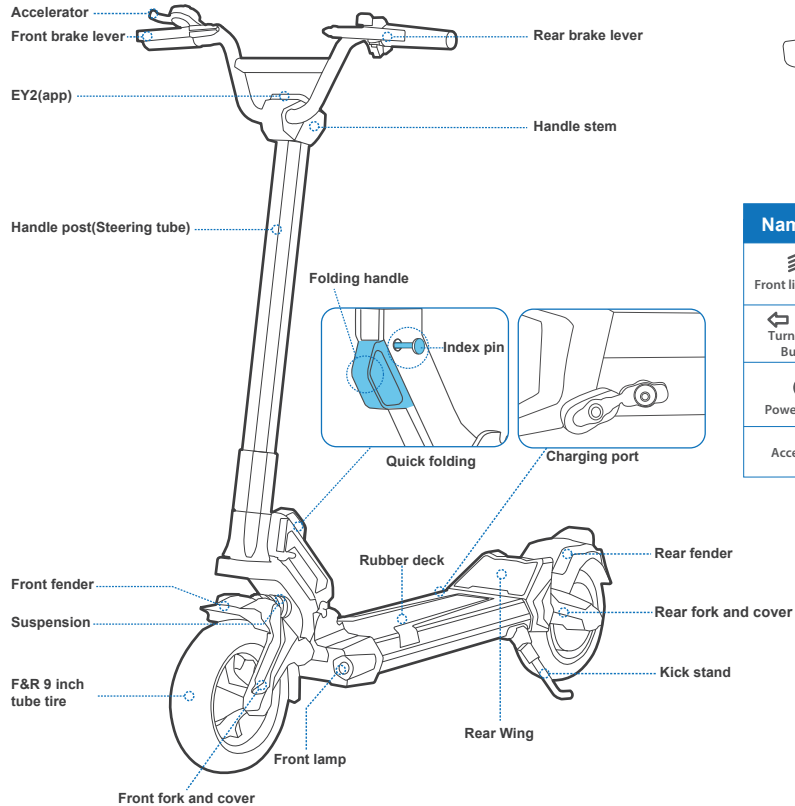

## Diagram And Functions



Name	Function	Operation method
 Front light button	Turn on/off Front light	Press the button, turn on/off the Front light.
 Turn Signal Button	Turn on/off the left/right signal	Press the left/right arrow of the Turn Signal Button, the left/right turn signal will keep blinking.
 Power Button	Turn on/off power	Press and hold the Power Button to turn on /off the scooter
Accelerator	Speed up	Pull the throttle to accelerate.



## Specifications

	Item	Parameter				
<b>Product</b>	Model	Dualtron Togo			Dualtron Togo Plus	
<b>Battery</b>	Battery Capacity	36V7.8Ah	36V12Ah	36V15Ah (Samsung)	48V12Ah	48V15Ah (Samsung)
	Range	20km	30km	40km	40km	50km
	Charging Ambient Temperature	0 to 40°C (Battery temperature exceeds 55°C, BMS start protection program.)				
	Battery Management System	Over-heating, short circuit, over-current, over-discharge and over-charge protection				
<b>Rider</b>	Max. load	100kg				
	Recommended Age	16-60 years old				
	Required Height	3'11" -6'6" (120-200 cm)				
<b>Display</b>	Type	EY2 display(DUALTRON APP available)				
<b>Motor</b>	Motor Type	BLDC Hub Motor				
	Nominal Power	420W			760W	
<b>Machine</b>	Net Weight	Around 22.8kg	Around 23.5kg	Around 23.7kg	Around 24.3kg	Around 24.4kg
	Max. Slope	Around 26.8% [ 15° ]				
	Drive System	Single motor drive				
	Speed	25km/h				
	Length x Width x Height	1200x615x1130mm				
	Folded: Length x Width x Height	1160x615x400mm				
	Wheelbase	Approx. 940mm				
	Ground Clearance	90mm				
	Traversable Terrain	Asphalt/flat pavement; obstacles < 5 cm; gaps < 5 cm				
	Operating Temperature	-5 to 45°C				
	Storage Temperature	-20 to 50°C				



## Specifications

<b>Brake</b>	Type	Dual drum brake	
	Electric Brake	ABS&EBS (Indicating the battery temperature exceeds 55°C,BMS start protection program,ABS/EBS fails.)	
<b>Charger</b>	Input Voltage	100-120V/200-240V~	
	Max. Output Voltage	36V: 41.5V1.5A	48V: 54V1.5A
<b>Tire</b>	Type	9 inch tire 70/50-6.1	
	Tire Pressure	50PSI	
	Material	Rubber	
<b>Suspension</b>	Type	Front&rear spring suspension	

\*Disclaimer: this is not a legal opinion or legal advice. The information provided herein (including in the App) is for your convenience and information purpose only. It is not intended to cover every piece of law and/or regulation that may be applicable to this product. DUALTRON explicitly hereby disclaims any and all warranty and/or representation, express or implied, related to completeness, accuracy, up-to-date of such information. DUALTRON reserves the right but not obligation to correct, implement and/or update the information. You shall use the information at your own risk. It is your sole responsibility to learn and understand any and all the law and/or regulation, requirements, prohibition, restriction and/or limitation imposed by either law, government authority, court, private party or the others that may apply to your use of this product.

\*Theoretical Range: tested while riding with a full battery, 75 kg load, 25°C, at the speed of 25 km/h on average on pavement.

\*Typical Range: tested while riding with a full battery, 75 kg load, 25°C, at the speed of 50 km/h on average on pavement. (Some of the factors that affect range include speed, number of starts and stops, ambient temperature, etc.)

\*Max.Speed: tested while riding with a full battery,75kg load,25°C,straight road on flat road with no wind. (Some environmental factors can affect max speed,uneven roads, crooked roads, temperature, wind, etc.)



## Packing List

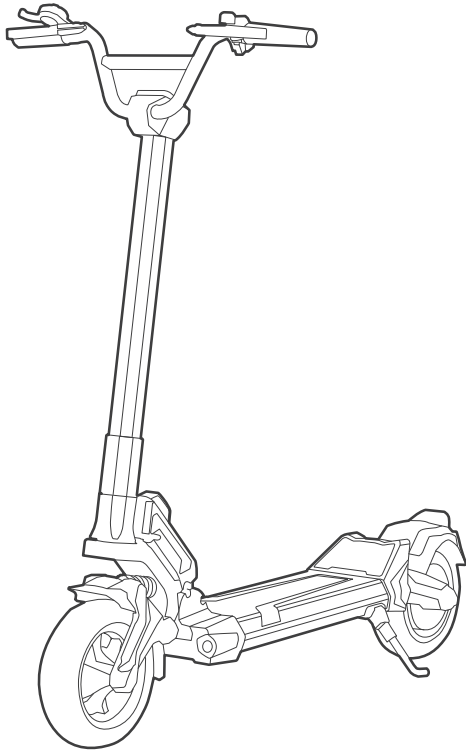

### Accessories



Charger x1

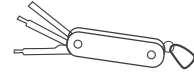

Multitool x 1



Manual

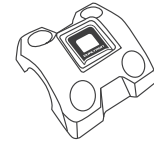

Handle neck upper

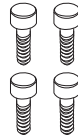

4 screws



## Assembly

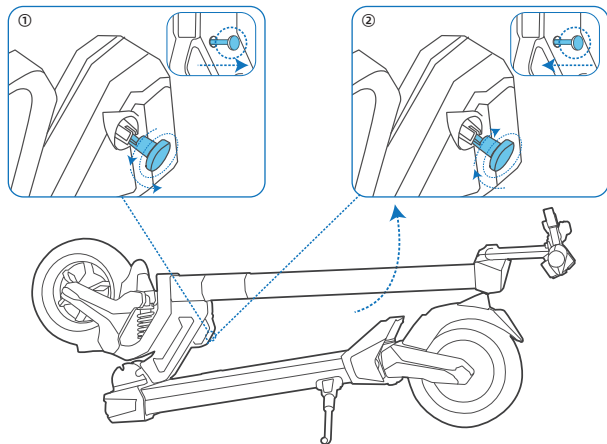

① Pull the index pin outward, then rotate it slightly to ensure a secure fit, the index pin will get stuck and the folding handle will work.

② Raise the steering tube and remember to reinsert the index pin to make this folding system more secure.

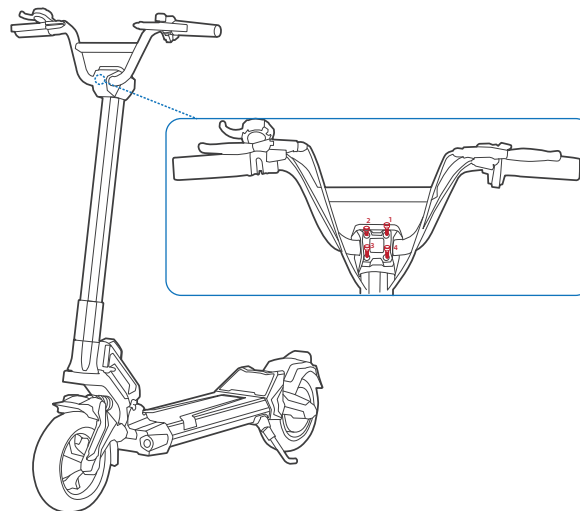

③ Attach the handlebar body and tighten the 4 screws. (When tightening the screw, the first step screw is 90% tight, according to the order 1-3-2-4; the second step all screws are 100% tightened.)





# Bluetooth Connection

## APP Download Guide

### Method 1

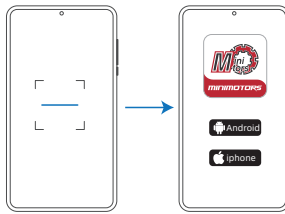

1. Scan the QR code to download the APP.
2. Choose the mobile phone system that suits you to install, and register / log in.

### Method 2



1. Search "DUALTRON" in the application and download it, and register / log in.

## Pair the Bluetooth on the APP

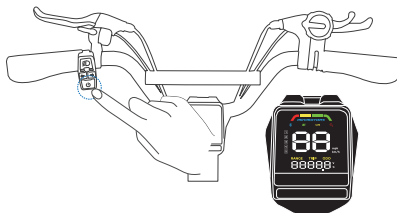

Power on the scooter.

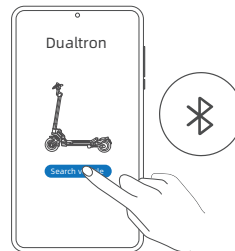

Click "Search vehicle" and pair with your scooter. \* The scooter is connected to the Dualtron app when the Bluetooth symbol lights up.

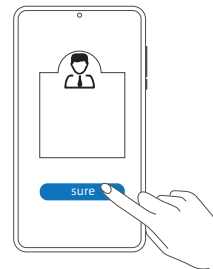

Select "bind as owner".  
(No one else can connect, only people authorized by you are allowed to connect. Authorizations are created on the app.)



## How to Ride

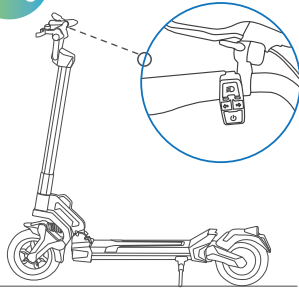

1. Power on the scooter and choose the speed mode. \* Please choose the speed mode before riding! Note: Speed mode can be choose via the Dualtron app.



2. Stand on the footboard with one foot and push off with the other foot to start gliding. \*Make sure you have disabled SAFE mode.(SAFE mode setting via Dualtron app.Deactivate safe mode by squeezing brake lever.)

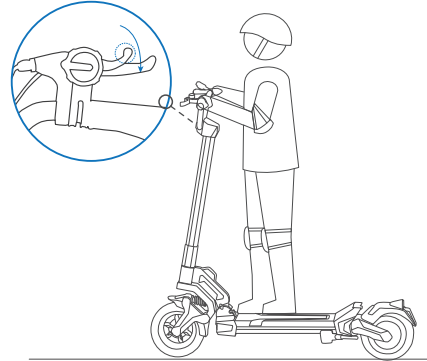

3. Put both feet on the footboard and stand stably. Pull the accelerator to speed up.

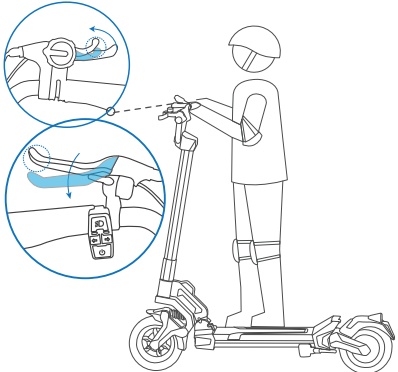

4. Slow down by releasing the accelerator and squeezing brake levers.

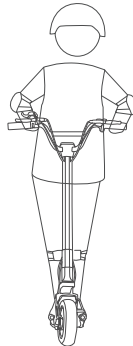

5. To turn, shift your body and turn the handlebar slightly.  
\* Please watch out for road conditions, sufficient turning space is required.

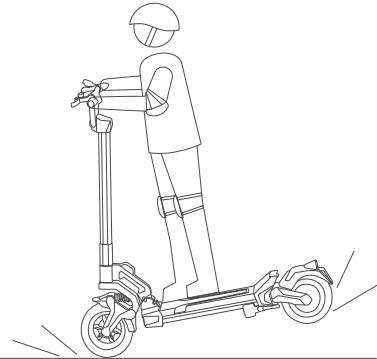

When hard braking, serious danger or injury may occur. Maintain a moderate speed and look out for potential hazards.



## Folding

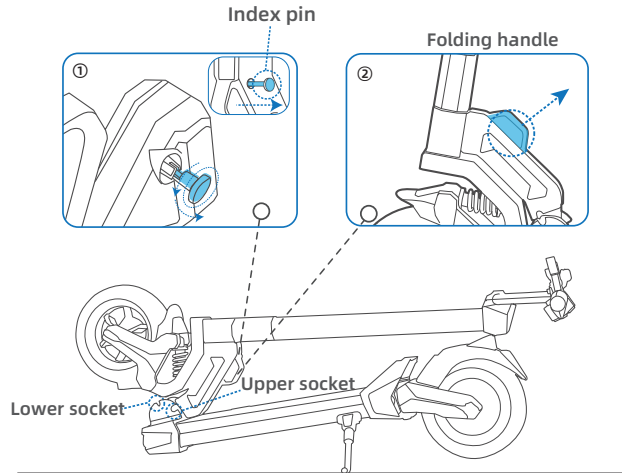

- ① Pull the index pin outward, then rotate it slightly to ensure a secure fit, the index pin will get stuck and the folding handle will work.
- ② Pull the folding handle, folding plunger will come out of the upper socket and slip to lower socket.

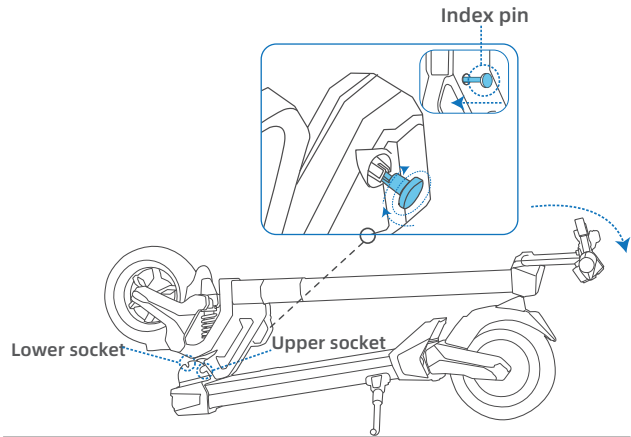

When the folding plunger gets stuck in lower socket and the folding handle resets in the stem headset, please remember to insert the index pin back to fix the folding system.

