

OOTD



Model: T10

USER MANUAL

Thank you for purchasing OOTD Electric Scooter, we will provide you with better products and better service

THANK YOU FOR CHOOSING OOTD

Contact us if you experience issues relating to riding, maintenance, and safety, or errors/faults with your Electric scooter.

 : Support@o-otd.com

 : [@Ootd_Scooters](https://twitter.com/Ootd_Scooters)

 : [@ootd_scooters](https://www.instagram.com/ootd_scooters)

 : WWW.O-OTD.COM

Contents

1 RIDING SAFETY	02
2 PACKING LIST	04
3 DIAGRAM	05
4 INSTRUMENT INTRODUCTION	06
5 ASSEMBLING YOUR ELECTRIC SCOOTER	07
6 CHARGING	08
7 LEARNING TO RIDE	08
8 RIDING NOTICE	10
9 DANGEROUS ACTIONS (NO ATTEMPTING!)	11
10 FOLDING AND CARRYING	12
11 DAILY CARE AND MAINTENANCE	13
12 SPECIFICATIONS	14
13 LIMITED WARRANTY STATEMENT	14
14 AFTER-SALES SERVICE	16
15 REGULAR INSPECTION & MAINTENANCE	17

1 Riding Safety

1. The Electric scooter is a recreational product. Before mastering riding skills, you need to practice. We are not responsible for any injuries or damage caused by a rider's inexperience or failure to follow the instructions in this document.
2. Please understand that you can reduce the risk by following all the instructions and warnings in this manual, but you cannot eliminate all the risks. Remember that whenever you ride the Electric scooter you risk injury from loss of control, collisions, and falls. When entering into public spaces always comply with local laws and regulations. As with other vehicles, faster speeds require longer braking distances. Sudden braking on low traction surfaces could lead to wheel slip or falls. Be cautious and always keep a safe distance between you and other people or vehicles when riding. Be alert and slow down when entering unfamiliar areas.
3. Always wear a helmet when riding. Use an approved bicycle or skateboard helmet that fits properly with the chin strap in place, and provides protection for the back of your head.
4. Do not attempt your first ride in any area where you might encounter children, pedestrians, pets, vehicles, bicycles, or other obstacles and potential hazards.
5. Respect pedestrians by always yielding the right of way. Pass on the left whenever possible. When approaching a pedestrian from the front, stay to the right and slow down. Avoid startling pedestrians. When approaching from behind, announce yourself and slow down to walking speed when passing. Please obey local traffic laws and regulations if the situation is different.
6. In places without laws, comply with the safety guidelines outlined in this manual. We are not responsible for any property damage, personal injury/death, accidents, or legal disputes caused by violations of the safety instructions.
7. Do not allow anyone to ride your Electric scooter on his/her own unless they have carefully read this manual. The safety of new riders is your responsibility. Assist new riders until they are comfortable with the basic operation of the Electric scooter. Make sure each new rider wears a helmet and other protective gear.
8. Before each ride check for loose fasteners and damaged components. If the Electric scooter makes abnormal sounds or signals an alarm, immediately stop riding. Contacting us through E-mail: support@o-otd.com for service.
9. Be alert! Scan both far ahead and in front of your Electric scooter — your eyes are your best tool for safely avoiding obstacles and low traction surfaces (including, but not limited to, wet ground, loose sand, loose gravel, and ice).
10. To reduce the risk of injury, you must read and follow all “CAUTION” and “WARNING” notices in this document. Do not ride at an unsafe speed. Under no circumstance should you ride on roads with motor vehicles. The manufacturer recommends riders be 14+ years old. Always follow these safety instructions:

A. People who should not ride the Electric scooter include:

i. Anyone under the influence of alcohol or drugs.

ii. Anyone who suffers from a disease that puts them at risk if they engage in strenuous physical activity.

iii. Anyone who has problems with balance or with motor skills that would interfere with their ability to maintain balance.

iv. Anyone whose weight is outside the stated limits (see Specifications). v. Pregnant women.

B. Riders under the age of 18 years old should ride under adult supervision.

C. Comply with local laws and regulations when riding this product. Do not ride where prohibited by local laws.

D. To ride safely, you must be able to clearly see what is in front of you and you must be clearly visible to others.

E. Do not ride in the snow, in the rain, or on roads that are wet, muddy, icy, or that are slippery for any reason. Do not ride over obstacles (sand, loose gravel, or sticks). Doing so could result in a loss of balance or traction and could cause a fall.

11. Do not attempt to charge your Electric scooter, the charger, or the power outlet is wet.

12. As with any electronic device, use a surge protector when charging to help protect your Electric scooter from damage due to power surges and voltage spikes. Do not use a charger from any other different product models.

13. Do not modify your Electric scooter. Modifications to your Electric scooter could interfere with the operation of the Electric scooter, result in serious injury and/or damage, and void the Limited Warranty.

14. Children should not play with the Electric scooter or parts of it nor should cleaning or maintenance be done by children. The use of the machine results in the transmission of vibrations throughout the driver's body.

15. Always place the Electric scooter on its stand on a flat and stable surface. The Electric scooter must be placed with the stand against the slope to prevent it from tipping over. Never place the Electric scooter with the front facing down the slope, as the stand may close and tip the machine. Once the Electric scooter is on its stand, check its stability to avoid any risk of falling (by slip, wind, or slight jolt). Do not park the Electric scooter in a busy area, but rather along a wall. If possible, always choose to park your Electric scooter on flat ground.

16. For a better driving experience, it is recommended to conduct regular maintenance of the product.

17. Please read the user manual before charging the battery.

18. Do not touch the brake system, it could cause injuries.

2 Packing List

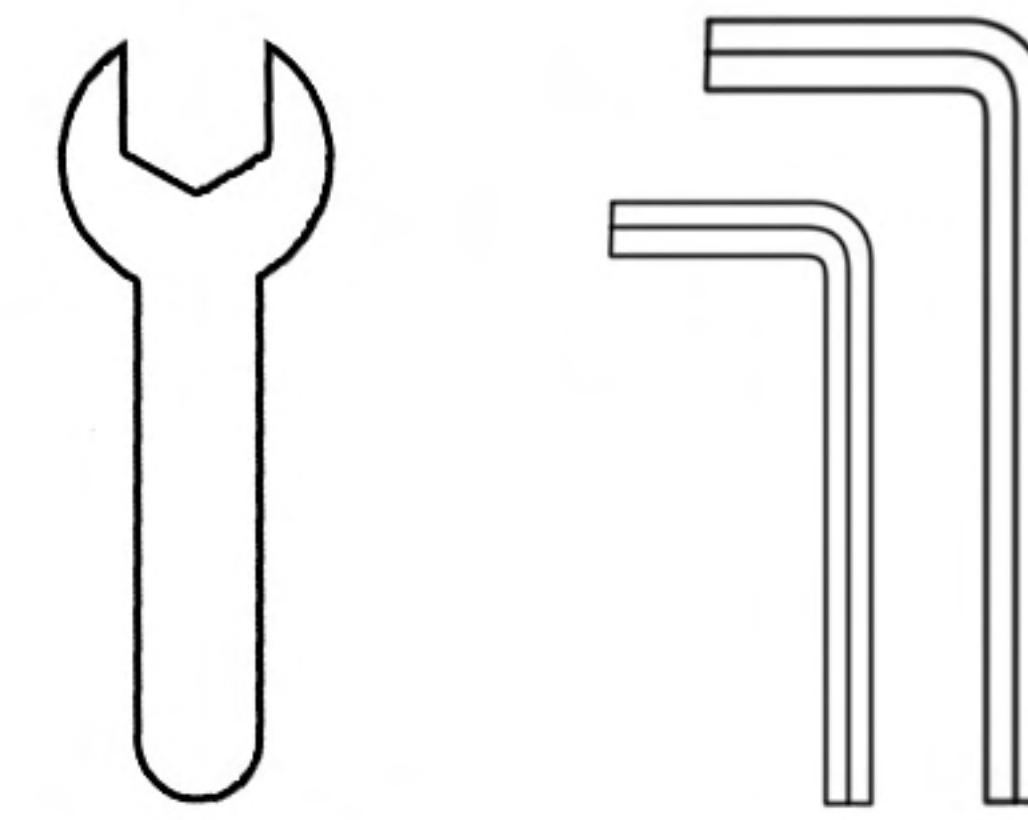

TOOL

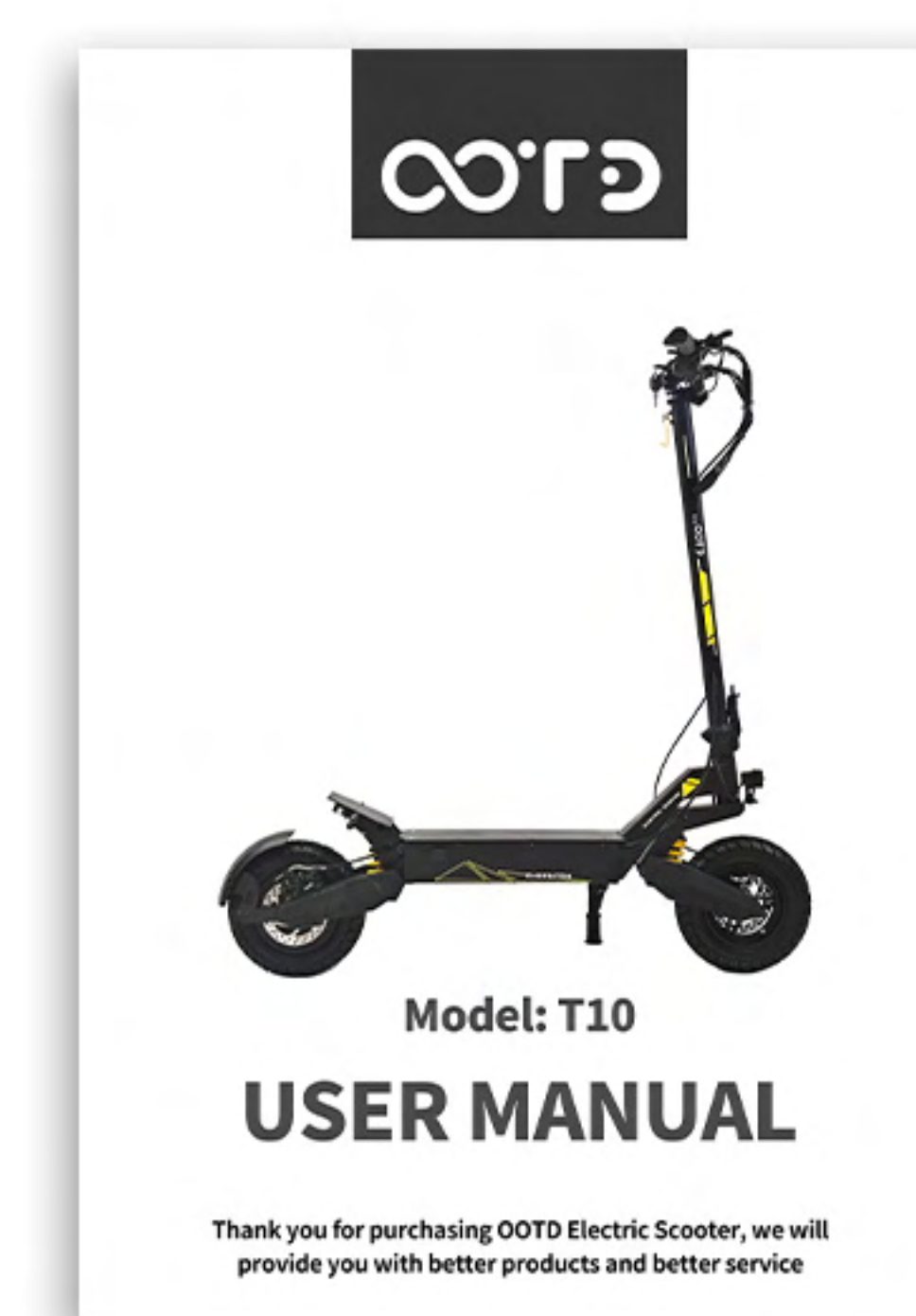

Manual

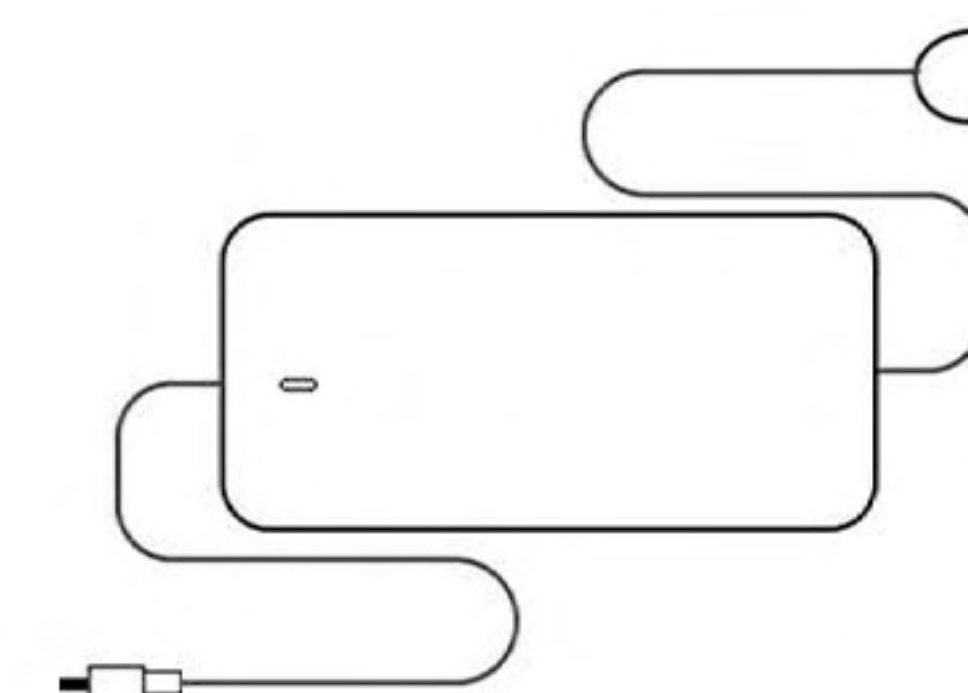

Charger

Carefully check package contents, if anything is missing or damaged, please contact our customer service for support: support@o-otd.com

After verifying that all components are present and in good condition, you can assemble your new Electric scooter.

Please retain the box and packaging materials in case you need to ship your Electric scooter in the future.

Remember to power off your Electric scooter and unplug the charging cable before assembling, mounting accessories, or cleaning the mainframe.

Always use both an electronic brake and a foot brake for emergency stops. Otherwise, you risk falls or collisions from not achieving the max braking capability.

* The picture is for reference only. Please refer to the actual product for more details.

3 Diagram



- 1. Handlebar
- 2. Stem
- 3. Headlight
- 4. Front shock absorber
- 5. Disc brake
- 6. Kickstand
- 7. Turn signal
- 8. Rear fender

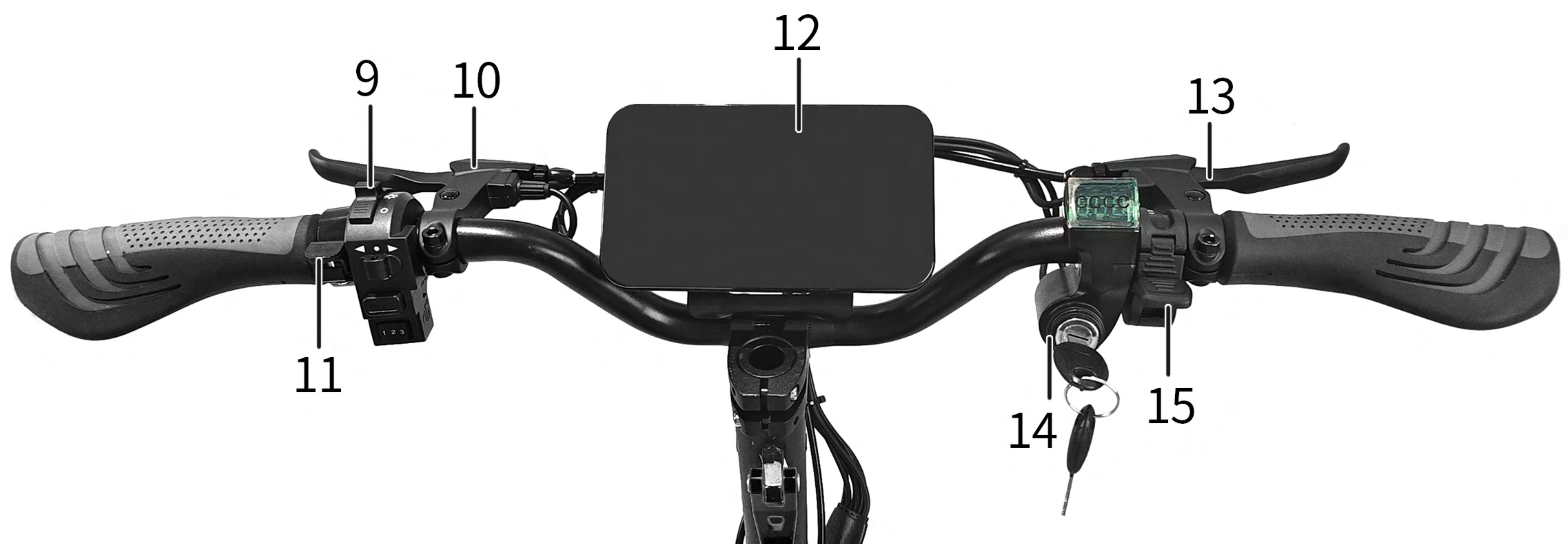

- 9. Light switch
- 10. Front brake lever
- 11. Scooter Bell
- 12. Display
- 13. Rear brake lever
- 14. On/Off Voltage lock
- 15. Accelerator

4 Instrument introduction

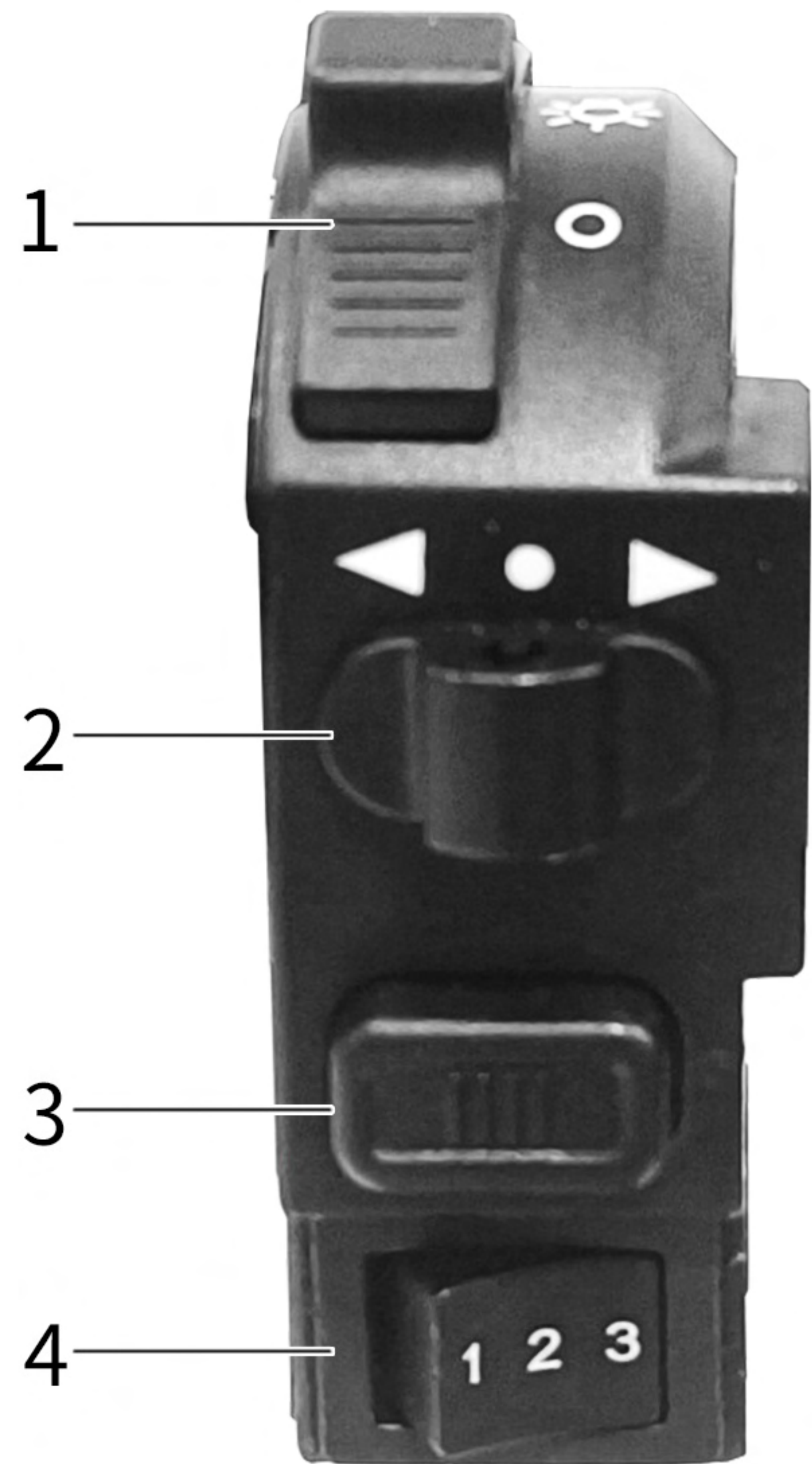

1. High beam switch - light is white

2. Turn signal button

3. Low beam switch - light is yellow

4. Gear shift button - there are three gears in total



		ECU					
CHARGE	MOTOR FAILURE	CONTROLLER FAILURE	BRAKING	1ST GEAR LOW SPEED	2ND GEAR MEDIUM SPEED	3RD GEAR HIGH SPEED	HANDLEBAR FAILURE
		TRIP	ODO				
HEADLIGHTS	THE WIDTH LIGHT	SINGLE MILEAGE	TOTAL MILEAGE	TURN LEFT	TURN RIGHT	P GEAR PARK	

5 Assembling Your Electric scooter

1. Unfold the scooter's stem and secure the folding latch.



2. Attach the handlebar to the buckle, tighten the screws, and then install it aligned with the pole, making sure it is oriented correctly.



3. Install the handlebar using the hex screwdriver, securing the screws at the back.



4. Finally tighten all the screws.



6 Charging



Charge port



Charging steps:



Open the charge port cover.



Insert the charge plug.



Close the charge port cover when finished.

⚠ Do not connect the charger if the charge port or charge cable is wet. Do not charge or use your battery if it is damaged or see a trace of water. Your Electric scooter is fully charged when the LED on the charger changes from red (charging) to green (trickle charge). Close the charge port cover when not charging.

7 Learning to Ride

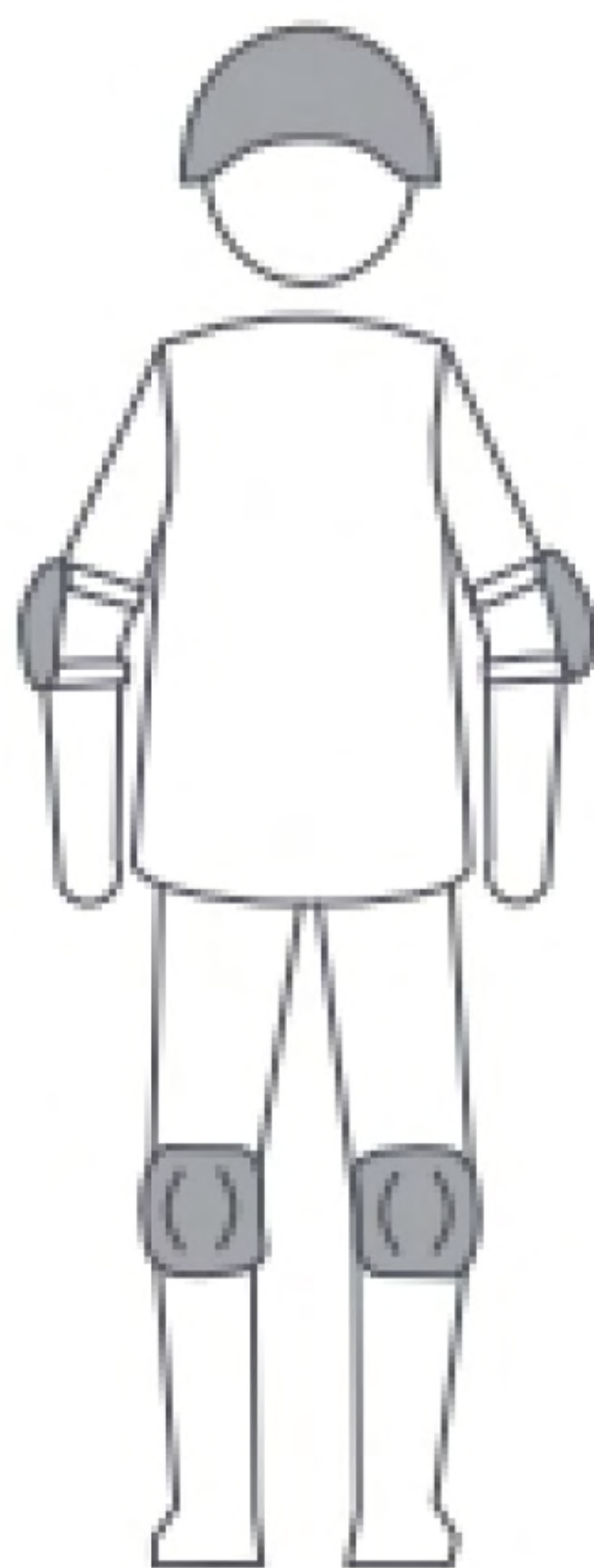

1. Wear an approved helmet and other protective gear to minimize any possible injury.



2. Use the key to turn on the voltage lock. Check the scooter's battery level, and charge it promptly if it's low.



3. Stand on the foot deck with one foot and push off with another foot to start gliding. If you bought a seat version, sit on the seat first. Speed up slowly.

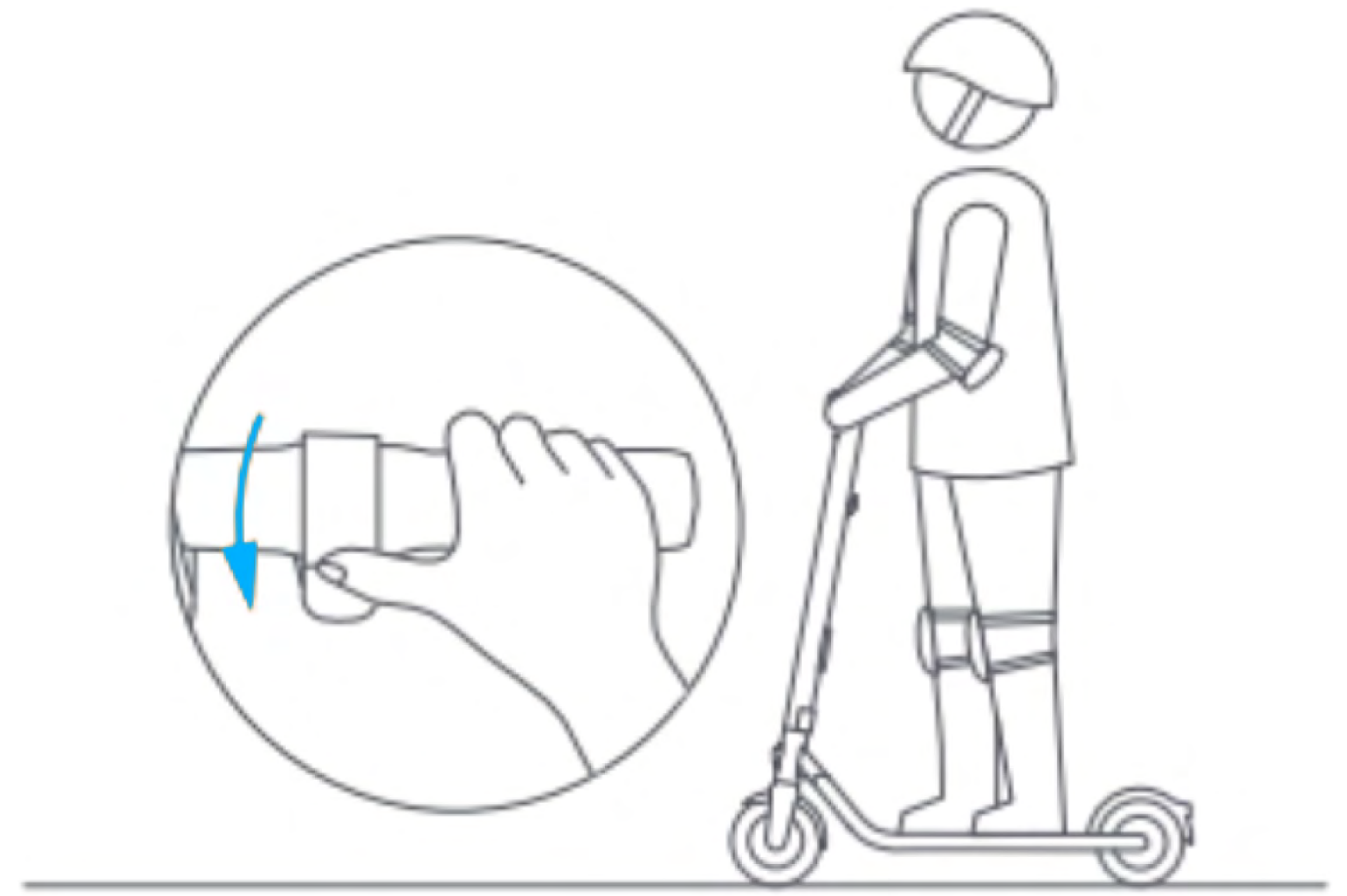

4. Put your other foot on the foot deck to keep both feet stable. Press the throttle to speed up when you are balanced.

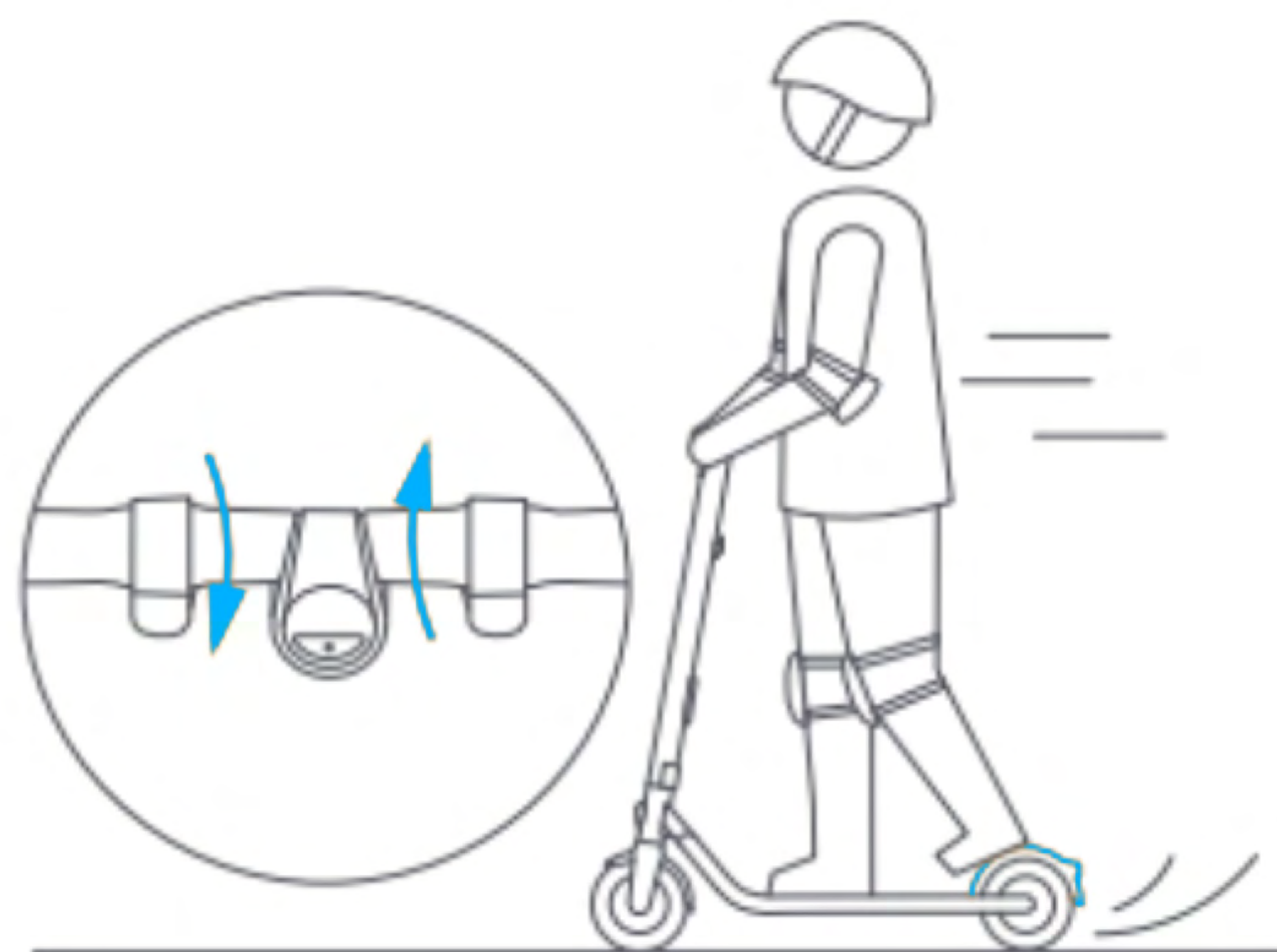

5. Slow down by releasing the throttle. Squeeze the brake and stamp the rear fender with your foot at the same time for a brake.

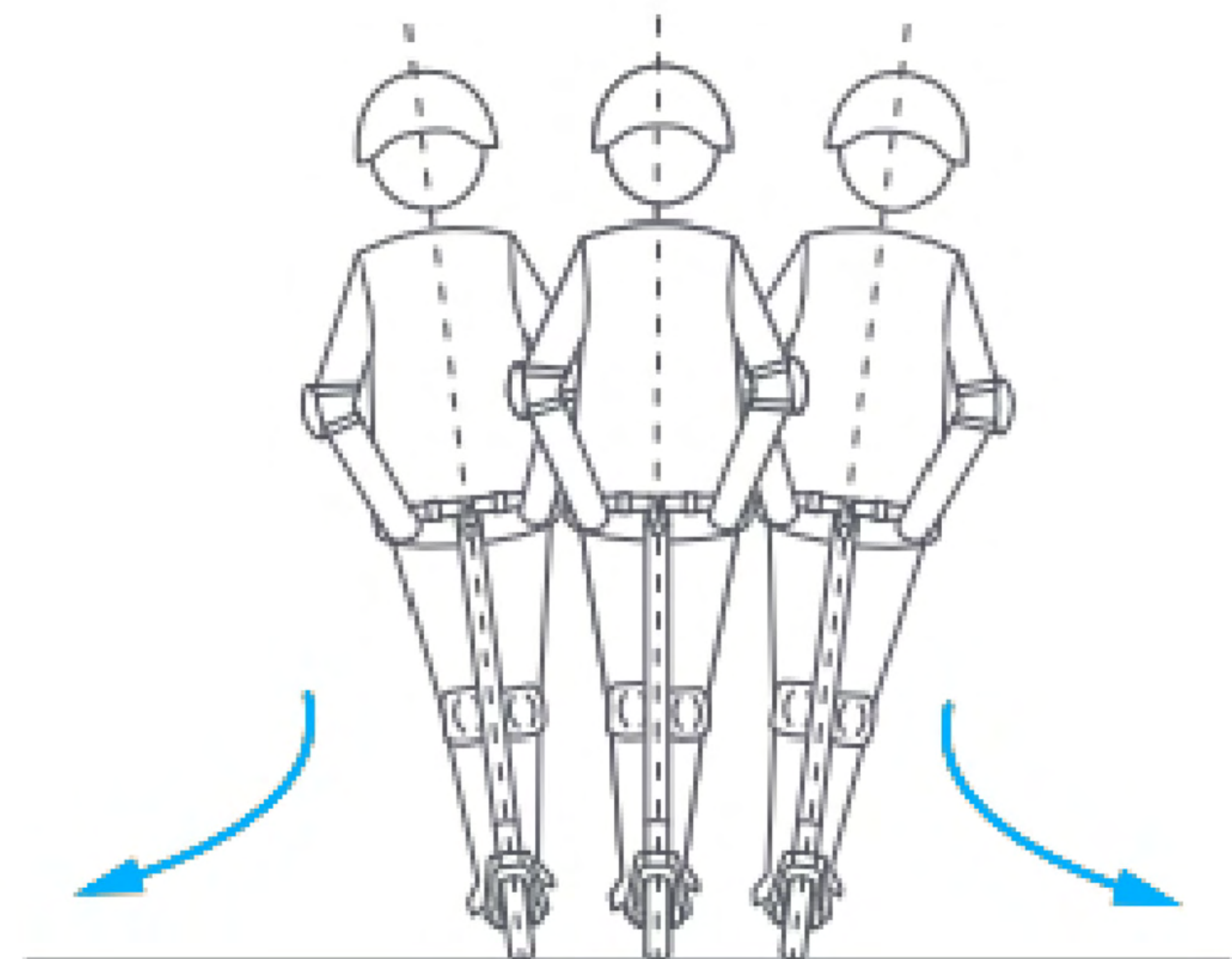

6. To turn, shift your body and turn the handlebar slightly.

⚠ WARNING

When braking rapidly, you risk serious injury due to loss of traction and falls. Maintain a moderate speed and look out for potential hazards.

8 Riding Notice



⚠ DO NOT ride the scooter in the rain.



⚠ Keep your speed between 3.1–6.2 mph (5–10 km/h) when you ride through speed bumps, elevator door stills, bumpy roads, or other uneven surfaces. Slightly bend your knee to better adjust mentioned surfaces.

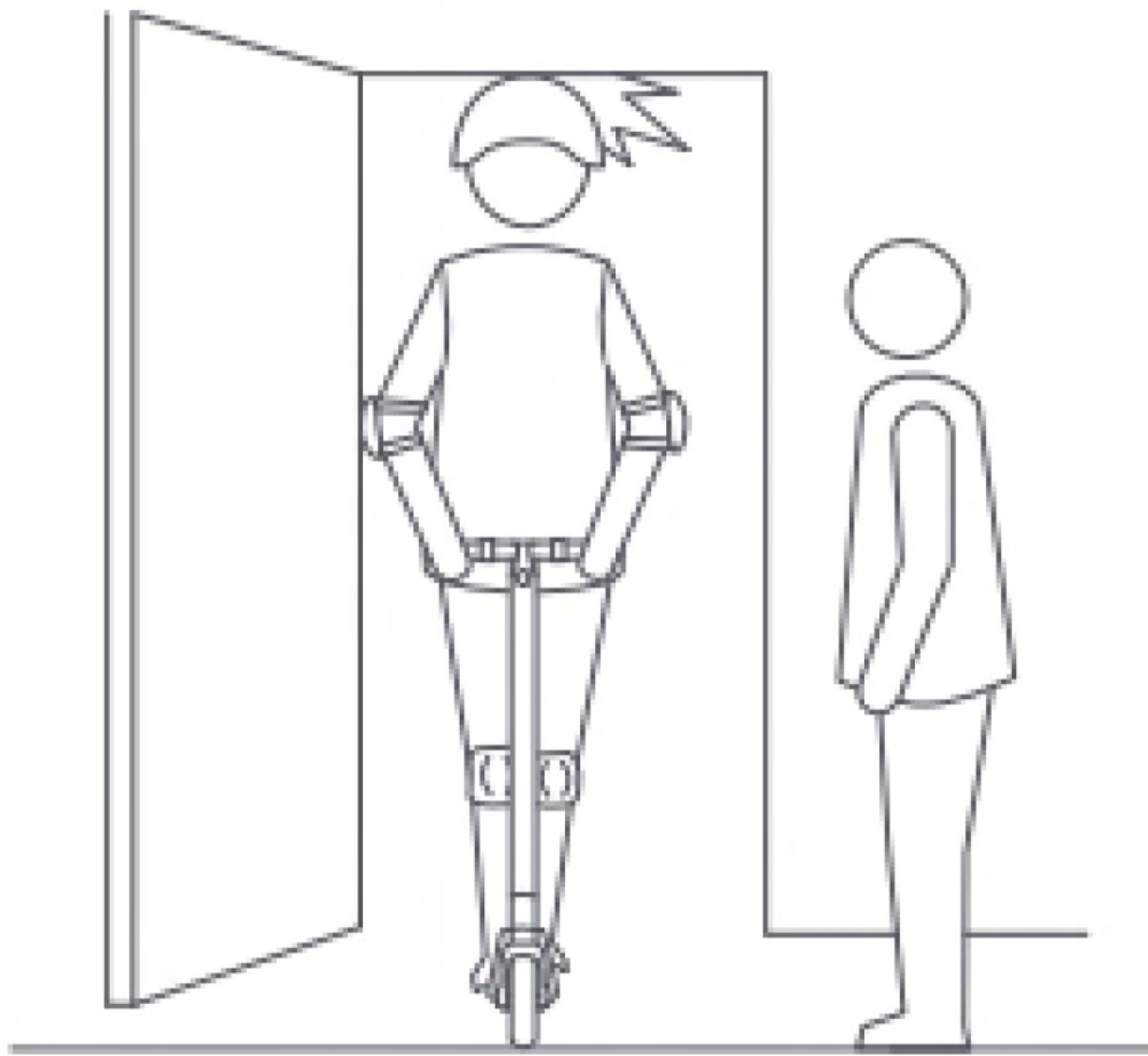

⚠ Watch your head when passing through doorways.



⚠ Watch your speed when traveling downhill. Use both brakes together when traveling at high speed.

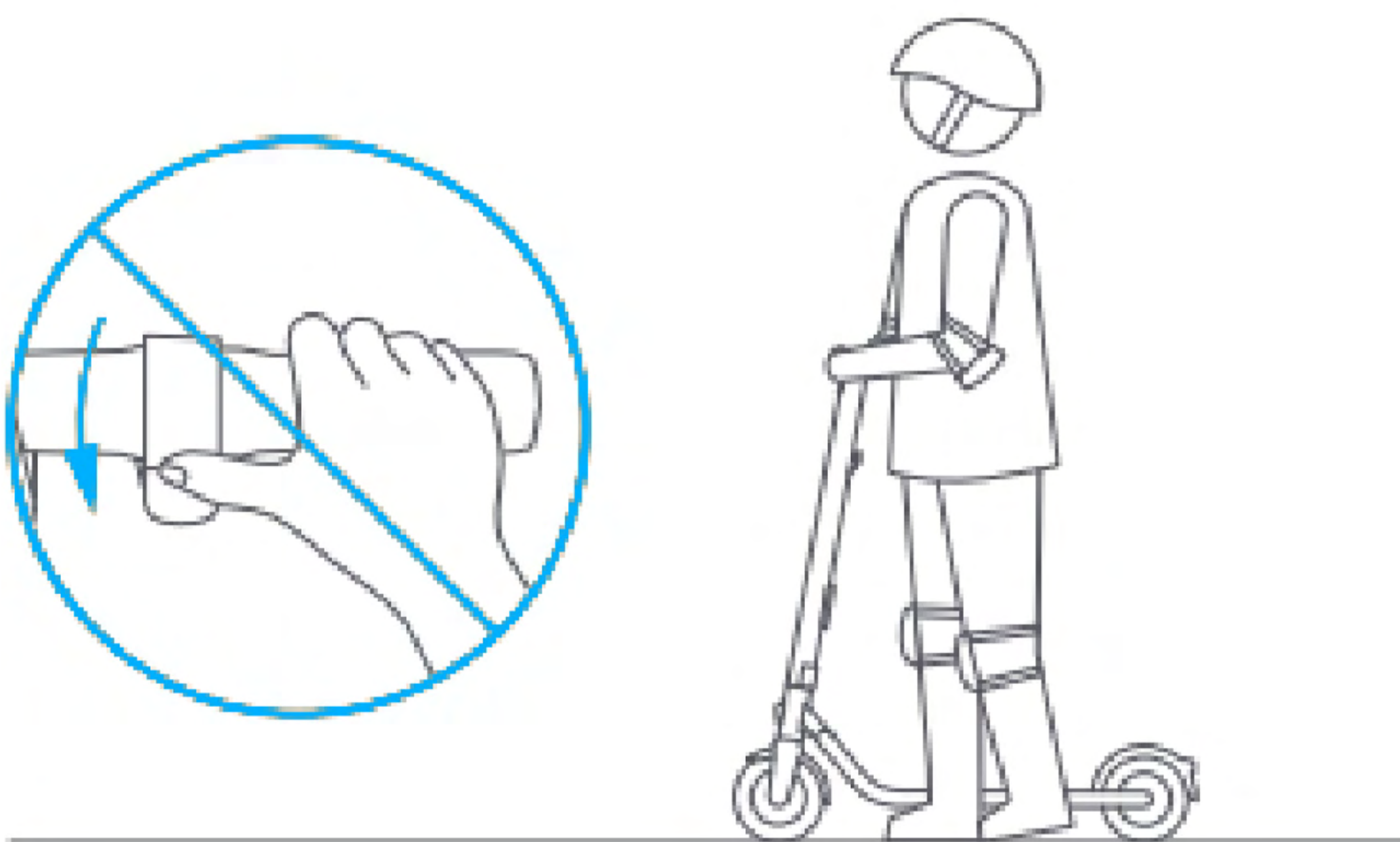

⚠ DO NOT press the throttle when walking with the scooter.

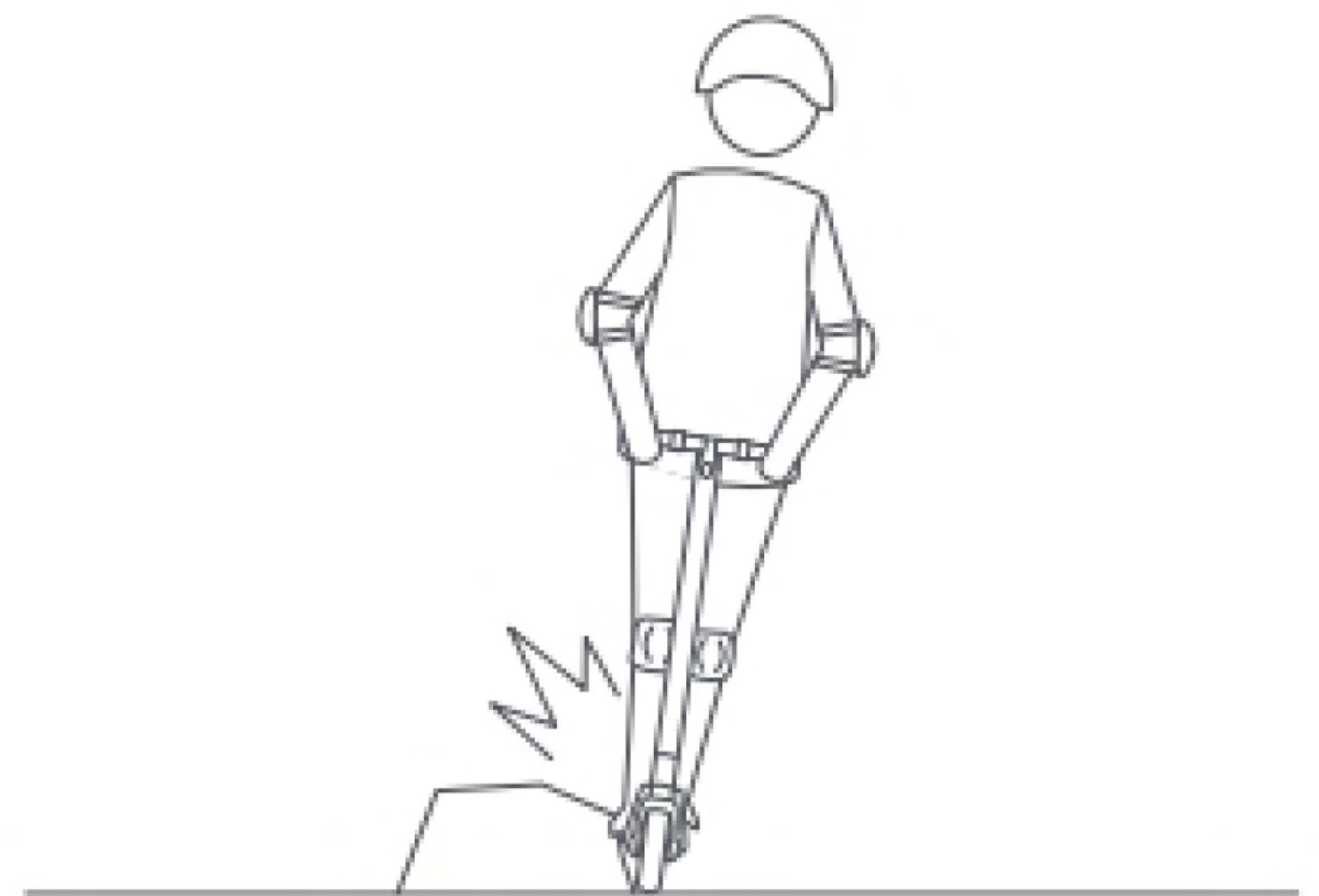

⚠ Avoid contacting obstacles with the tire/wheel.

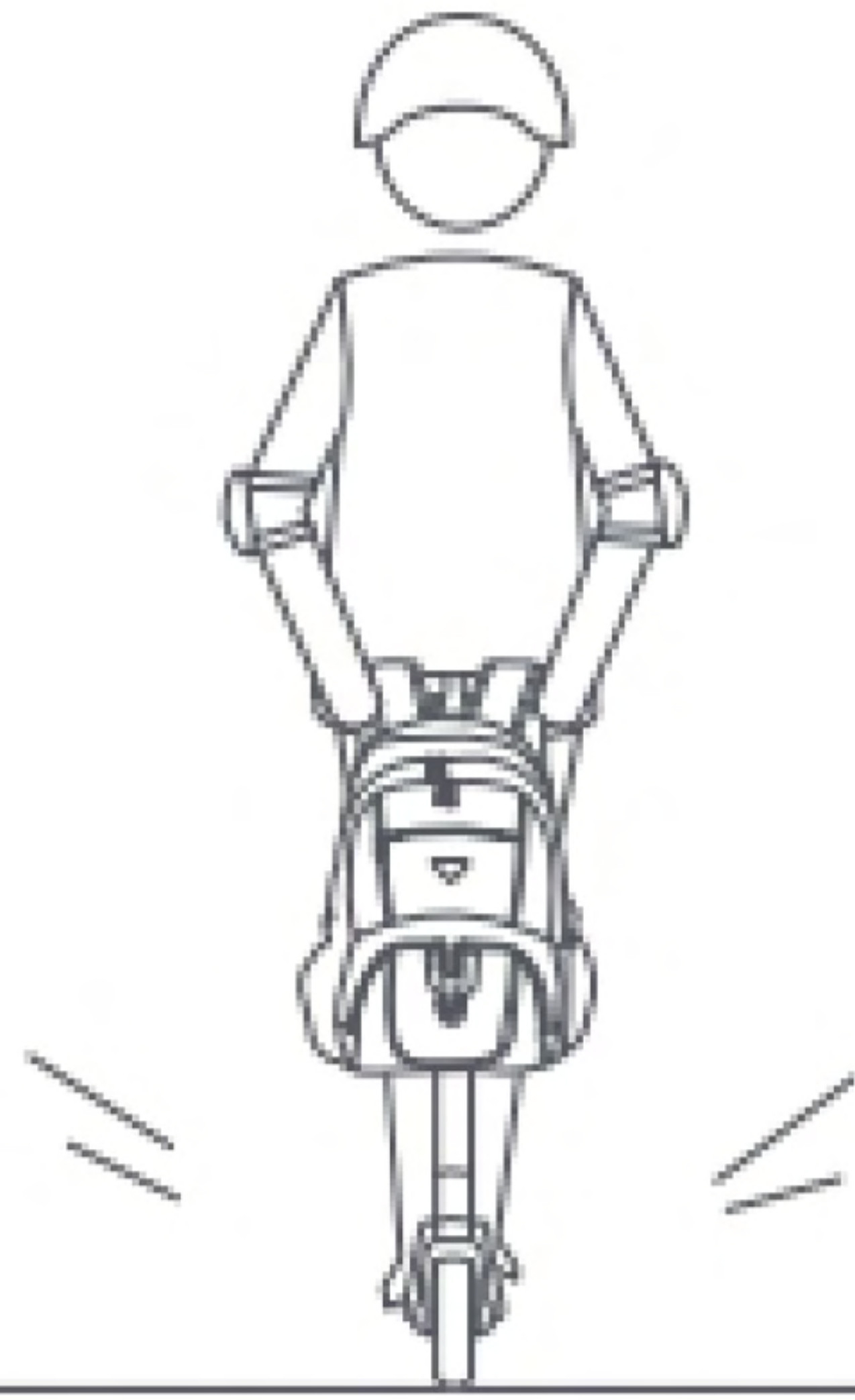

⚠ DO NOT carry heavy objects on the handlebar.

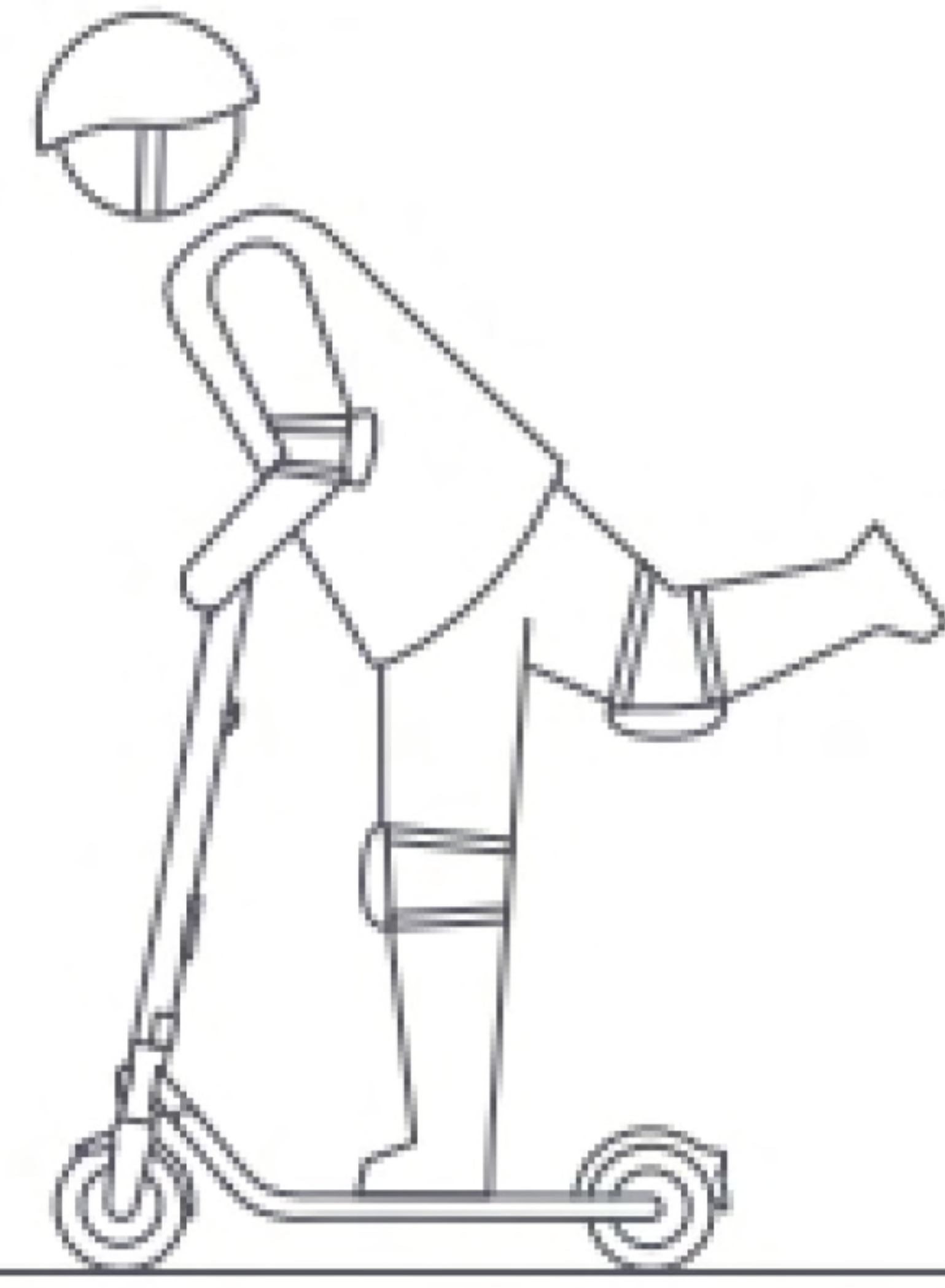

⚠ DO NOT ride the scooter with only one foot.

9 Dangerous Actions (No Attempting!)

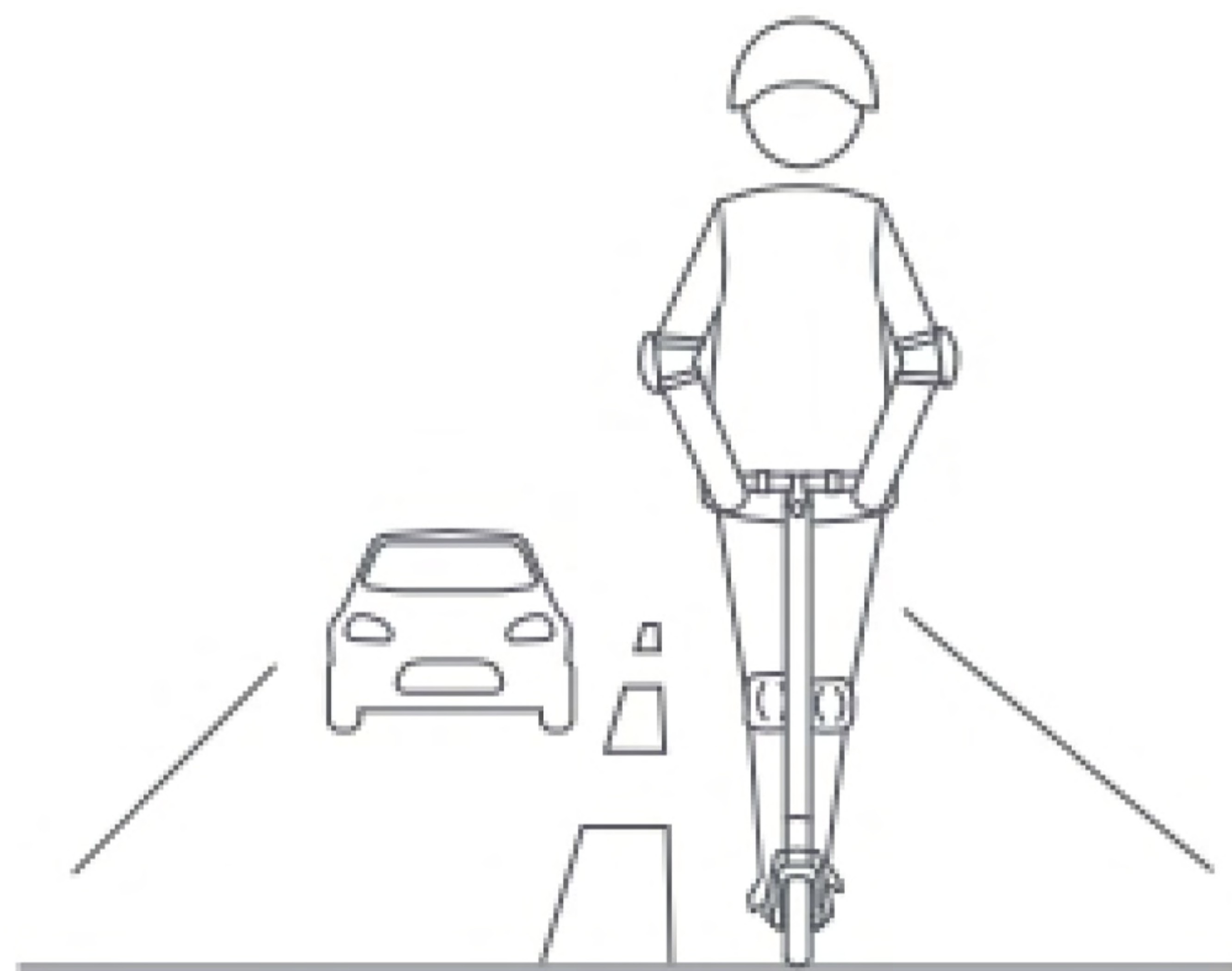

⚠ DO NOT ride on public roads, motorways, or highways.

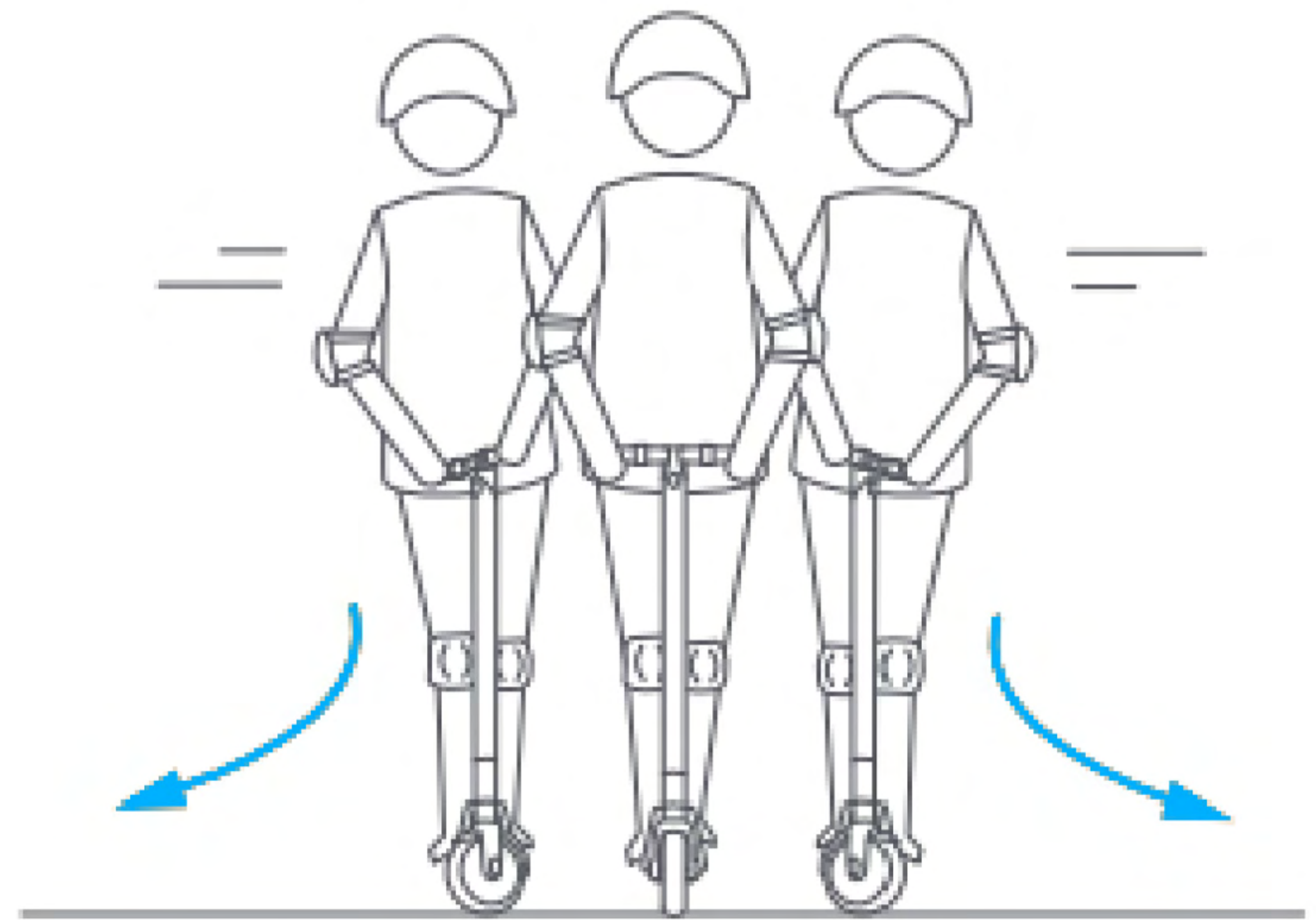

⚠ DO NOT rotate the handlebar violently while driving at high speed.



⚠ Do not ride through puddles or any other (water) obstacles. In such a case please lower your speed and bypass the obstacle.

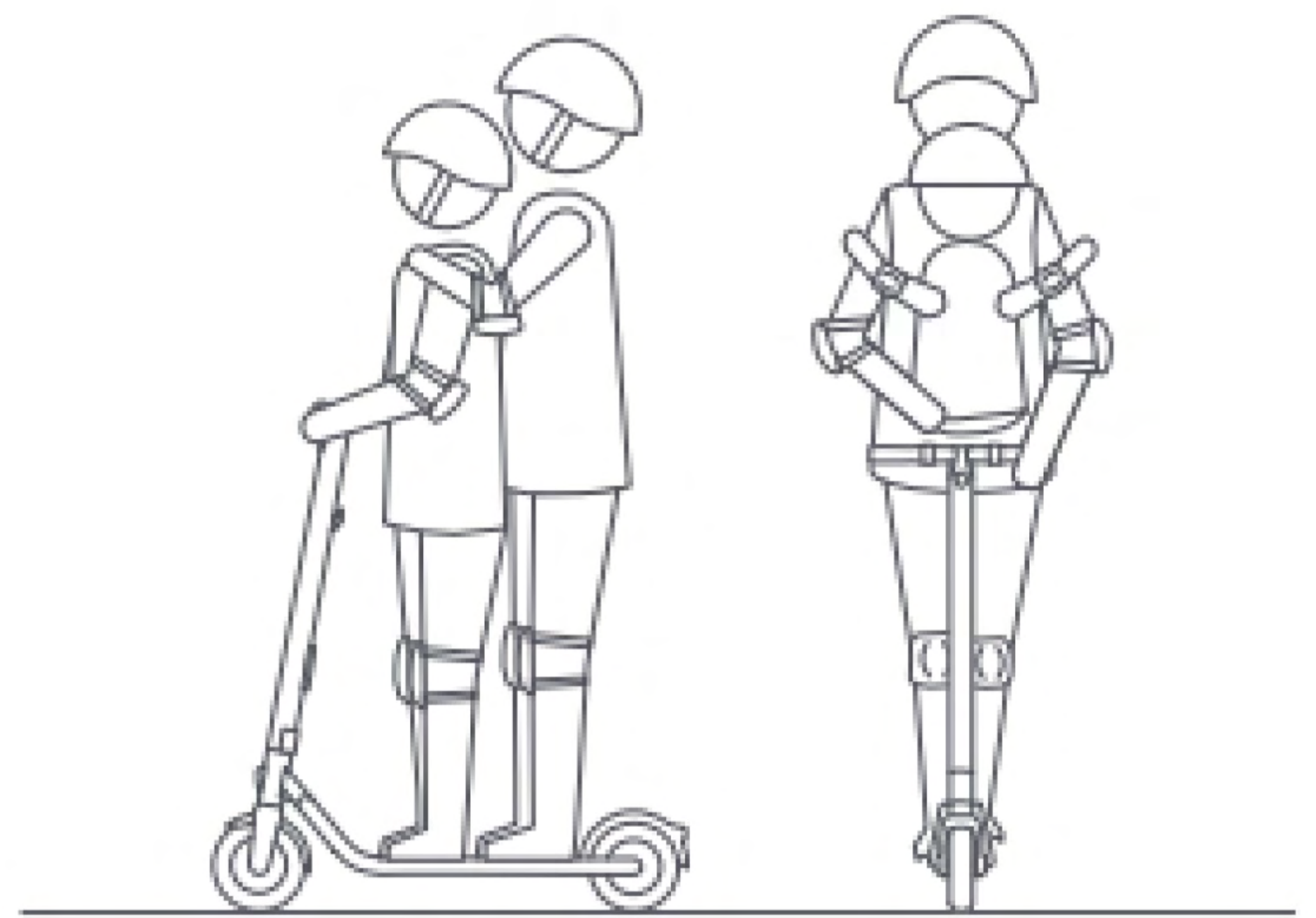

⚠ The Electric scooter is for one rider only. Do not ride with another person. Do not carry a child.

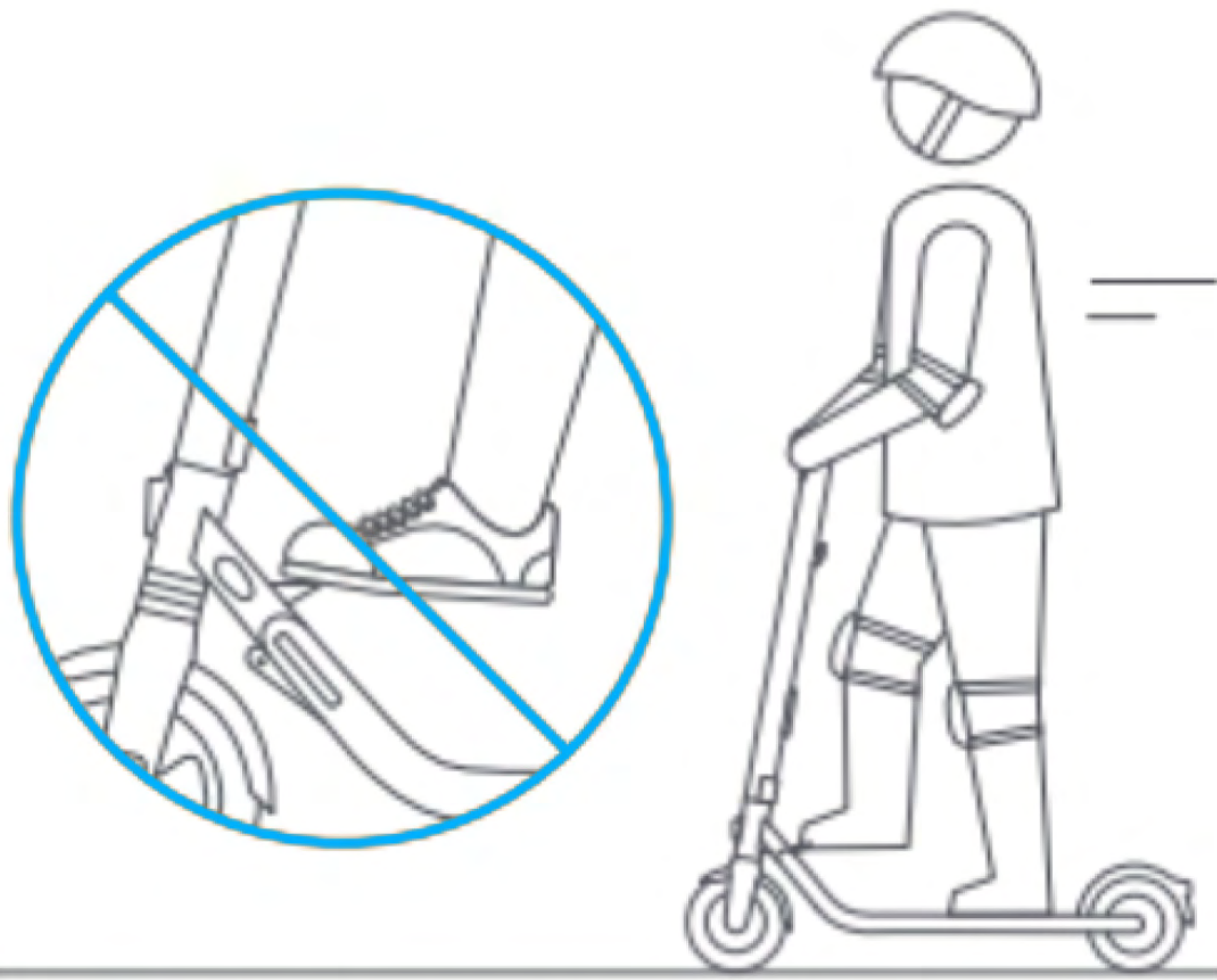

⚠ DO NOT step on the folding pedal while riding.

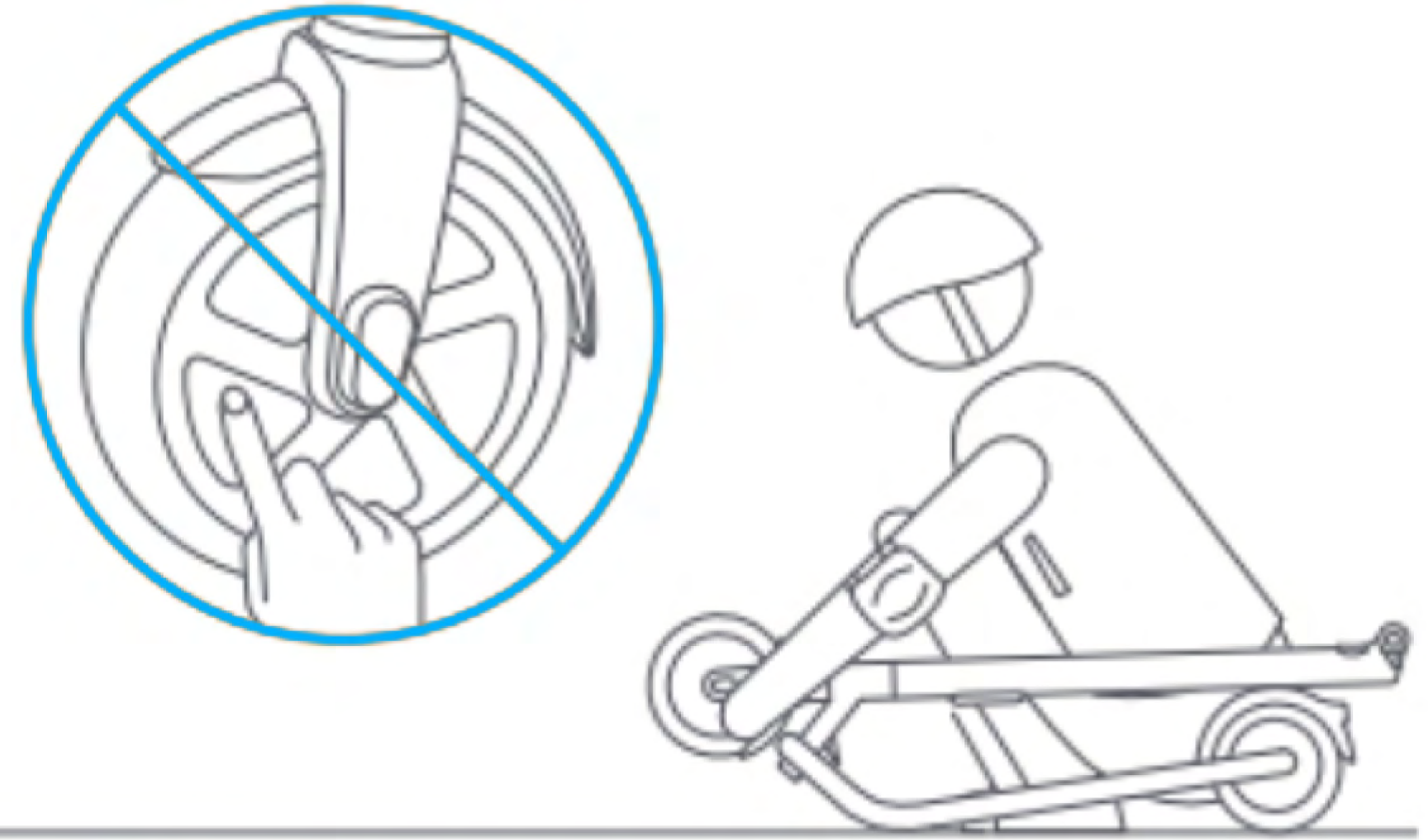

⚠ DO NOT touch the hub motor after riding because it can get hot.



⚠ DO NOT take your hands off the handlebar while riding. Do not ride with one hand only.

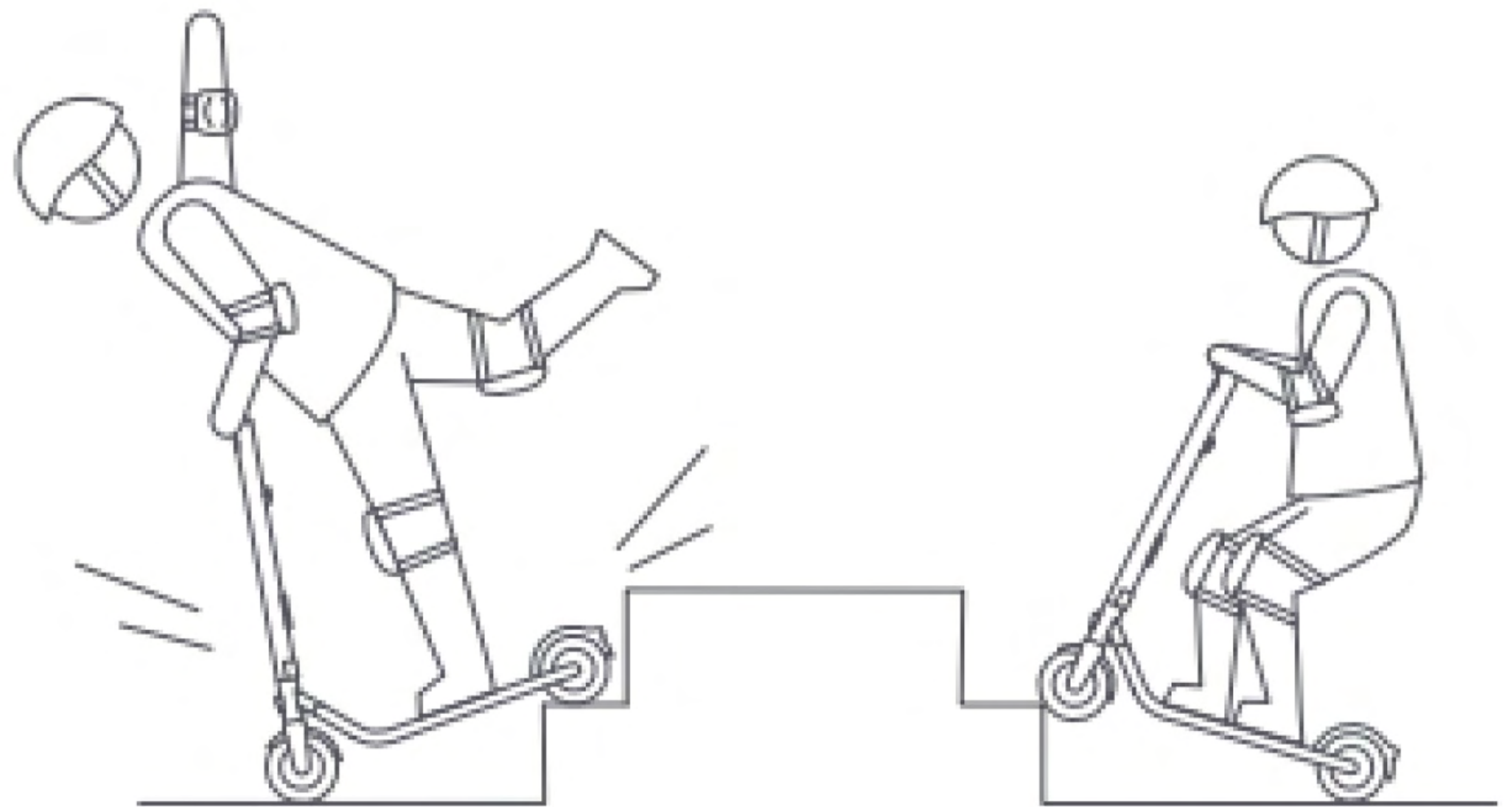

⚠ DO NOT ride up and down stairs or jump over obstacles.

10 Folding and Carrying

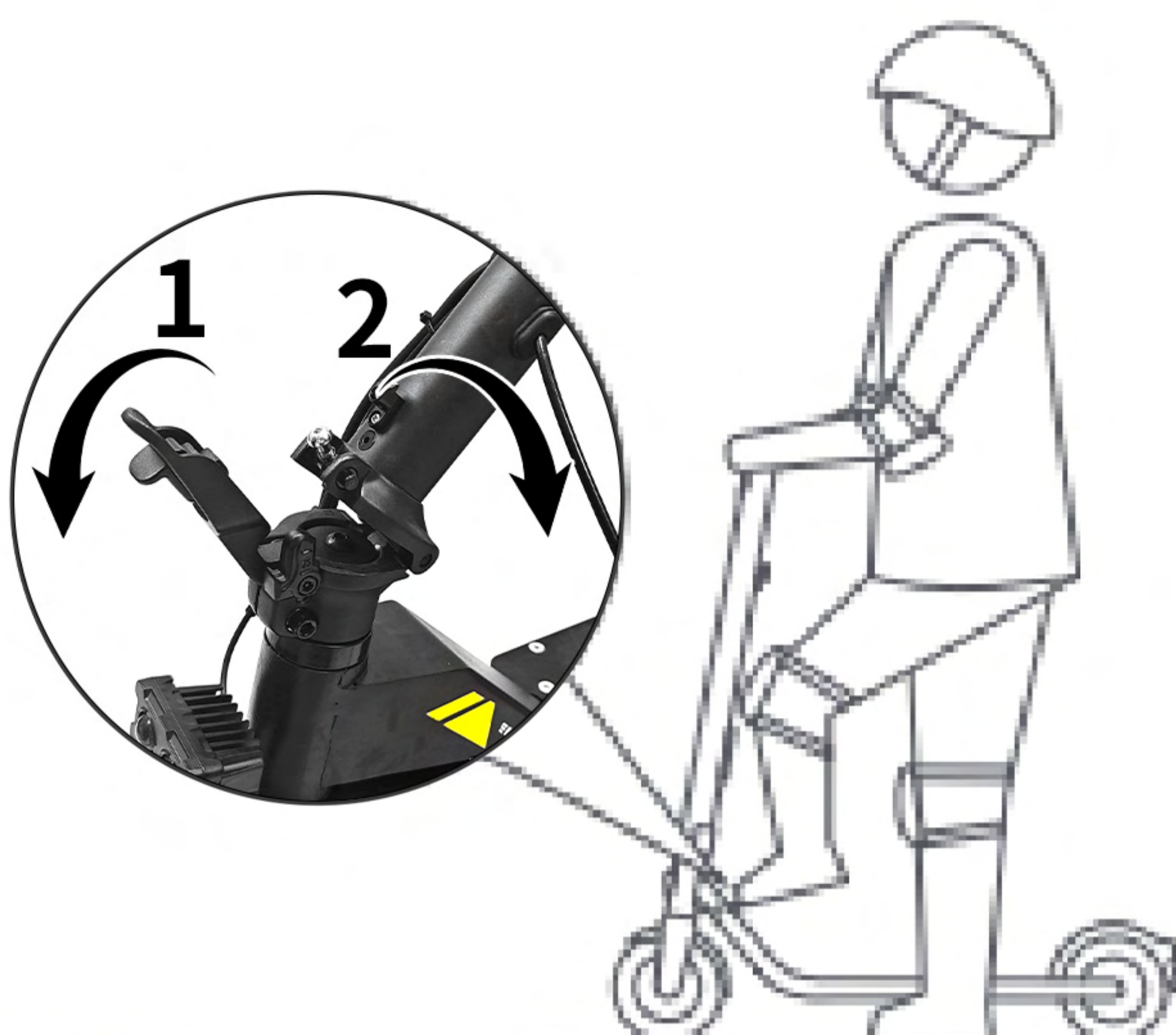

Make sure that the scooter's turned off. To fold, unlock the folding mechanism. Then fold the handlebar down.

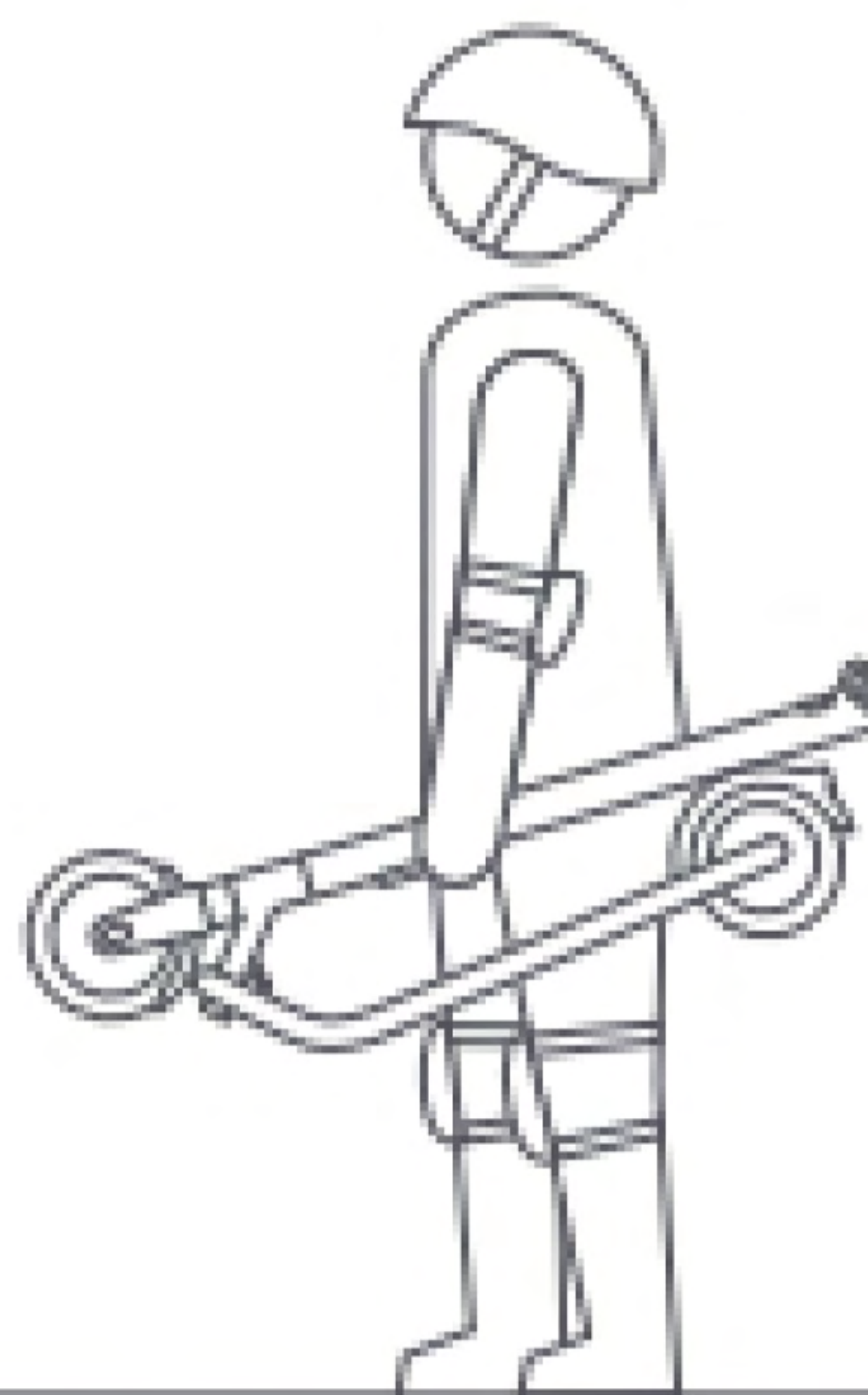

Hold the handlebar stem with either one hand or both hands to carry.

11 Daily Care and Maintenance

Cleaning and storage

If you see stains on the scooter's body, wipe them off with a damp cloth. If the stains won't scrub off, put on some toothpaste, and brush them with a toothbrush, then wipe them off with a damp cloth.

Notes: do not clean the scooter with alcohol, gasoline, kerosene, or other corrosive and volatile chemical solvents to prevent dire damage. Do not wash the board with a high-pressure water spray. During cleaning, make sure that the scooter's turned off, the charging cable is unplugged, and the rubber flap is closed as water leakage may result in electric shock or other major problems. When the scooter is not in use, keep it indoors where it is dry and cool. Do not put it outdoors for a long time. Excessive sunlight, overheating, and overcooling accelerate the battery pack's lifespan.

Battery maintenance

1. Use original battery packs, use of other models or brands may bring about safety issues;
2. Do not touch the contacts. Do not dismantle or puncture the casing. Keep the contacts away from metal objects to prevent short circuits which may result in battery damage or even injuries and deaths;
3. Use the original power adapter to avoid potential damage or fire;
4. Mishandling of used batteries may do tremendous harm to the environment. To protect the natural environment, please follow local regulations to properly dispose of used batteries.
5. After every use, fully charge the battery to prolong its lifespan.

Storage and Disposal

1. Please try to store the scooter in a cool and dry place between 14° and 104°. In extremely humid environments the interior of the scooter may suffer condensation or even water accumulation, which may damage the battery rapidly. Devices are not intended for use at elevations greater than 2000 m above sea level Prolonged Exposure to UV Rays, Rain and the Elements May Damage the Enclosure Materials, Store Indoors When Not in Use.
2. In daily use, try to avoid recharging the scooter after completely exhausting the battery. If the battery is low, charge it as soon as possible.
3. Please charge the scooter every other month to preserve the battery.

12 Specifications

T10	Items	Electric Scooter
T10	Unfolded(Length * Width * Height)	1270*670*1220mm
	Package Size(Length * Width * Height)	1260*230*550mm
Weight	Net Weight	31kg
User	Load	150kg
	Recommended Age	16-50
Scooter	Max Speed	25km/h
	Max range	30-40km
	Max Slope	25-35°
	Operating Temperature	-10-40°C
	IP Rating	IPX5
Battery	Voltage	48V DC
	Max. Charging Voltage	67.2V DC
	Capacity	13Ah
Motor	Peak power	250w
Charger	Input Voltage	110V-240V
	Output Voltage	54.6V DC
	Output Current	3A
	Charging Time	4-5hours

- (1) The height of the body: distance from the ground to the highest end of the body.
- (2) Description of the battery life: it is measured under the condition of full charge, a load of 165 lbs (75 kg), 77°F (25°C), on a flat road without wind, and at 25km/h of max speed. The real battery life will differ with different factors of load, humidity, wind speed, and operation habits.
- (3) The maximum allowable weight shall be kept within 150kg (driver and objects included)in any case. Considering the extra weight of the clothes or other accessories with us during the trip and the gravity generated by speed, the scooter will not support it if this load limit is exceeded.

13 Limited Warranty Statement

7-DAY SATISFACTION GUARANTEED RETURN POLICY

If you are unsatisfied with your purchase, our return policy allows you to return the product purchased on the Authorization channel within 7 days counting from the date of receipt of shipment, and request a refund from the Authorization channel for any reason. Note: Express shipping cost is non-refundable.

For the return request, we are not responsible for lost packages due to the carrier, or products received that cannot be verified. Received products that have damage determined to have been caused by the end-user may be subject to denial of the return request.

LIMITED PRODUCT WARRANTY

We warrant to the original purchaser that your product shall be free from defects in materials and workmanship under normal use for the period aforementioned. We do not warrant the operation of the product will be uninterrupted or error-free. We are not responsible for damage arising from failure to follow instructions relating to the product's usage.

TO QUALIFY FOR A REFUND, ALL THE FOLLOWING CONDITIONS MUST BE MET:

1. A Return Merchandise Authorization (RMA) must be requested within 7 days from the date of receipt of shipment. To request an RMA, Contact us through E-mail: support@o-otd.com for service.
2. The cost of return shipping will be borne by the customer.
3. For warranty service, please keep your receipt and/or invoice to validate proof of purchase.
4. Returned product must be in good physical condition (not physically broken or damaged).
5. All accessories originally included with your purchase must be included with your return.
6. If you return a product to our warehouse, (a) without an RMA and without all parts included in the original package, we retain the right to refuse delivery of such a return.

REMEDIES

If a hardware defect is found and a valid claim is received by OOTD within the Warranty Period, we will, at its option and to the extent permitted by law, either repair the product at no charge, using new or refurbished replacement parts or, replace the product with a new or refurbished product. In the event of a defect, to the extent permitted by law, these are your sole and exclusive remedies. Shipping and handling charges may apply except where prohibited by applicable law. Any replacement hardware product will be warranted for the remainder of the original warranty period or seven (7) days, whichever is longer, or for any additional period of time that may be applicable in your jurisdiction.

HOW TO OBTAIN WARRANTY SERVICE

A Warranty Service Order must be requested within Warranty Period from the date of receipt of shipment. To request a Warranty Service Order, Contact us through E-mail: support@o-otd.com for service.

To obtain warranty service, you must deliver the product, in either its original packaging or packaging providing an equal degree of protection, to the address specified by the seller. In accordance with applicable law, we may require the customer to furnish proof of purchase details and/or comply with registration requirements before receiving a warranty service period or seven (7) days, whichever is longer, or for any additional period of time that may be applicable in your jurisdiction.

LIMITATION OF DAMAGES

Except to the extent prohibited by applicable law, we shall not be liable for any incidental, indirect, special, or consequential damages, including but not limited to loss of profits, revenue, or data, resulting from any breach of express or implied warranty or condition, or under any other legal theory, even when OOTD has been advised of the possibility of such damages. Some jurisdictions do not allow the exclusion or limitation of special, indirect, incidental, or consequential damages, so the above limitation or exclusion may not apply to you.

After-Sales Service

Part Name	Service Term	Warranty	Approach
Motor	12 months	Failure in normal use	1 year warranty for non-human damage
Battery	12 months	Failure in normal use	Normal attenuation is not covered by warranty
Instrument accelerator	12 months	Quality issues	1 year warranty for non-human damage
Controller	12 months	Quality issues	1 year warranty for non-human damage
Charger	12 months	Quality issues	Non-human damage can be guaranteed
Trumpet	12 months	No sound	Non-human damage can be guaranteed
Frame	12 months	Desoldering, nonartificial fracture	Non-human damage can be guaranteed
Tire	12 months	Air leakage (non-artificial or pierced)	Non-human damage can be guaranteed

Note: trade-in for the new one(within the warranty period)

Regular Inspection & Maintenance

C: Check A: Adjust R:Replace L: Lubricate T:Tighten

Inspection Items	60days	180days	360days
Whether the handlebar rotates or whether the steering parts are loose or worn	A/T	C/T	C/L
Whether the tire is properly inflated or the tire is worn	C	C	R
Front and rear axle gears, and wheel axles are deformed or worn	T	C/T	C/L
Whether the brake pad is worn		R	R
Whether the rim is deformed or deflection		C	C
Whether the frame and front fork are deformed or bruised		C	C
Is the braking works good?	C	C	C
Whether the horn and headlights are working properly		C	C
Whether the charger or charging plug is damaged		C	C
Whether the tightening screws are loose	A	A	A



Facebook



Instagram



Twitter



YouTube



WhatsApp



APP