

User Manual

Foldable Electric Scooter

Thanks for choosing our product,have fun with this electric scooter.

Contents

1. The Device&Accessories.....01

2. Functions.....02

3. Assembling.....03

4. Charging.....04

5. Driving Instructions.....05

6. Safety Recommendations.....06

7. Folding&Transportation.....11

8. Daily Maintenance and Storage.....12

9. Model Specifications.....14

1. The Device & Accessories

Vehicle

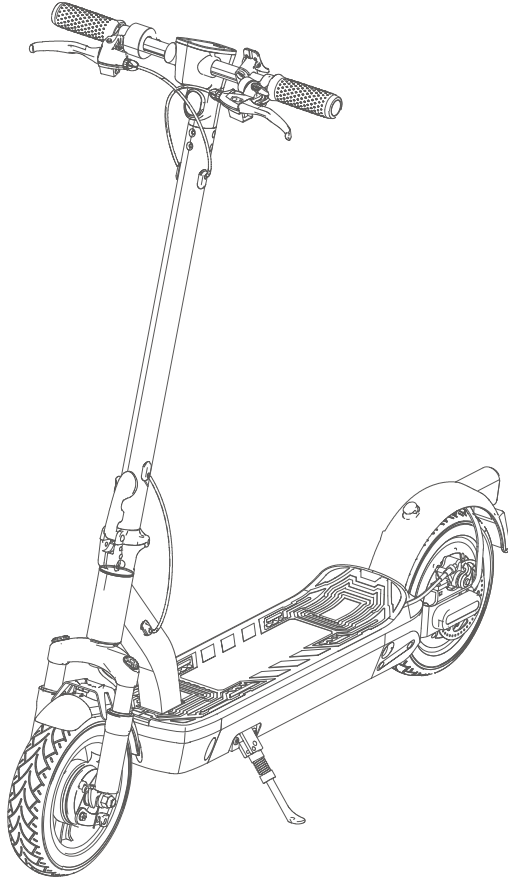

Accessories



Screws x6



Wrench



Charging Adapter

2. Functions

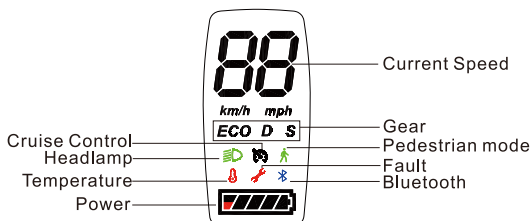
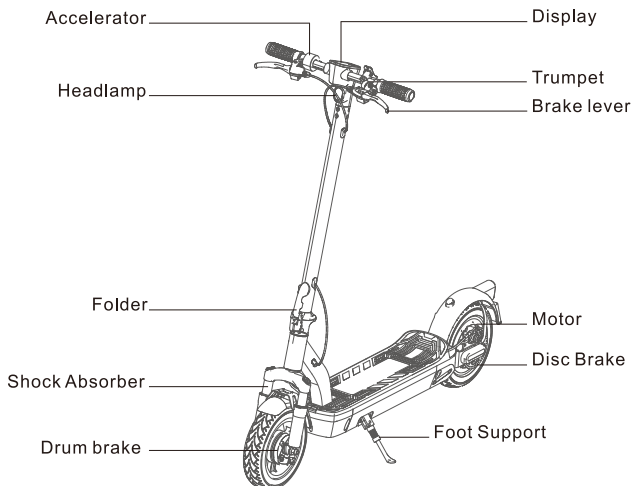

Instructions

1. Press and hold the power button for 2 seconds to turn on and off the machine.
- 2 Short press once to switch gears
- 3 Short press twice to turn on/off the headlights
- 4 Short press three times to switch to kilometers/miles display
- 5 Short press 4 times to turn on/off cruise control
- 6 Short press 5 times to switch between non-zero start/zero start
- 7 Short press 6 times to remove Bluetooth APP connection
- 8 Short press 7 times to clear the total mileage display in the APP
9. Hold the brake lever and press it quickly 5 times to turn on or off the speed limit.
10. When the car is locked, hold the brake lever and press and hold the power button for 10 seconds to force the car to shut down.

3. Assembling the device

1. Straighten the pole, lock and fold;

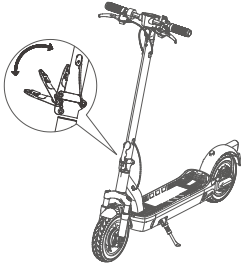

2. Install the head and tighten the screws;

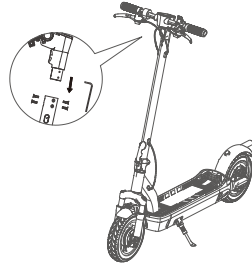

3. Long press the power button to turn on;

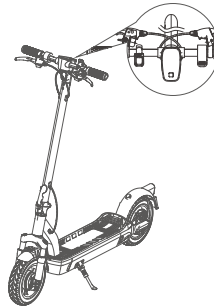

Power Button

Press the power button to turn on the vehicle. Press and hold the button for 2 seconds to run on the device. When on: Press the power button to turn the flashlight on/off; press the power button twice to enter the speed gear switching mode

4. Charging scooter

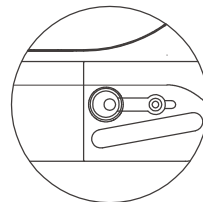
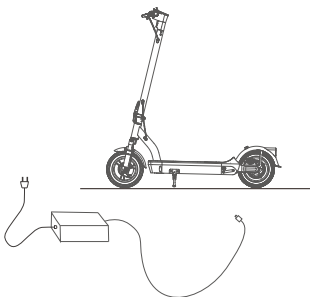

Open the cover Connect the charger

5. Learning driving

Please wear helmet and knee pads when practice

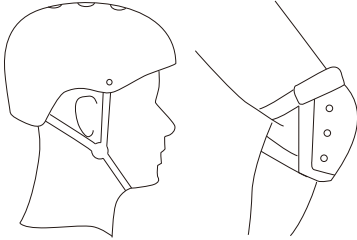

1. Power on and check the battery led light

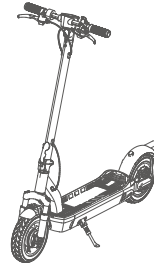

2. Stand on pedal with one leg

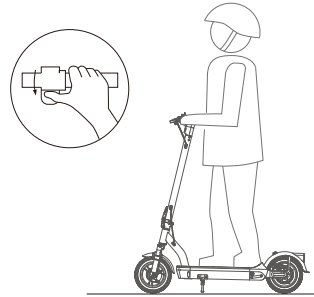

3. Step on the other leg when the scooter is moving, then press the accelerate button (only accelerate when the scooter speed is beyond 5km/h)

4. Loose the accelerate button when slow down. Energy recovery systems will open itself to slow down. Press the left disc brake tightly if want to brake urgently.

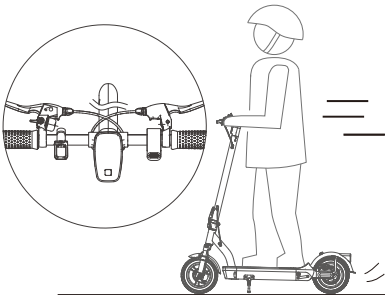

5. Lean your body left slightly to turn left, lean your body right slightly to turn right. And turn the handlebar slowly

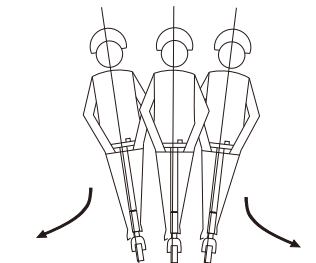

6. Safety instructions

It is not recommend driving on the rain



It is recommend to slightly bend knees to better agjust to a rough road. if you are travelling on a rough road, stick to low speed(5-10km/h)

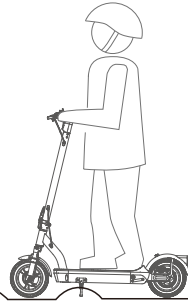

Entering into any room, elevator, etc.
Be careful not be injured by a door frame.

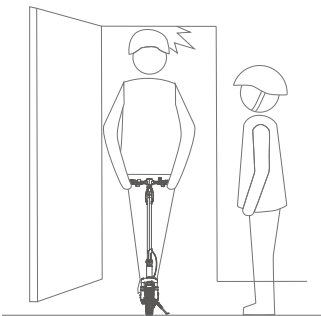

Please not add speed when
descending a hill.

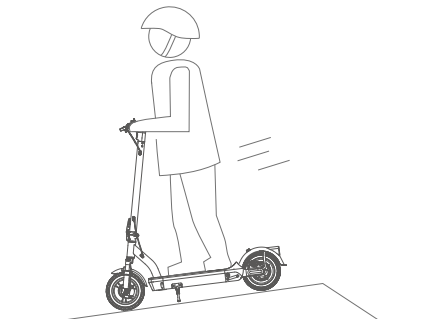

While walking a scooter,
do not press a speed knob

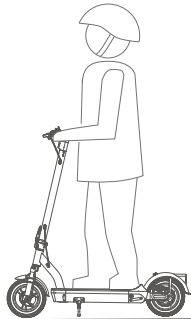
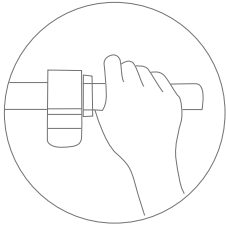

When driving it is recommended to
go around various obstacles on
a road

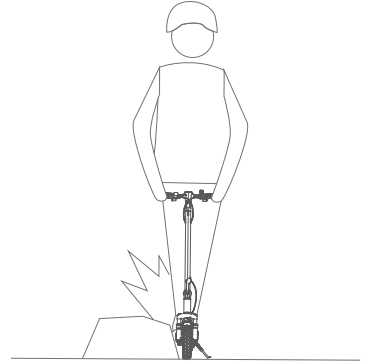

Please do not hang backpacks and
other heavy objects on handle bars
ground

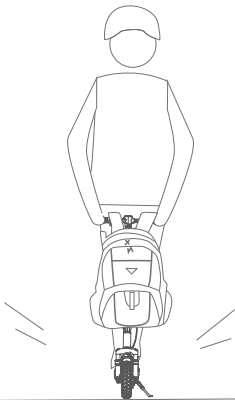

When driving is forbidden to place
one foot

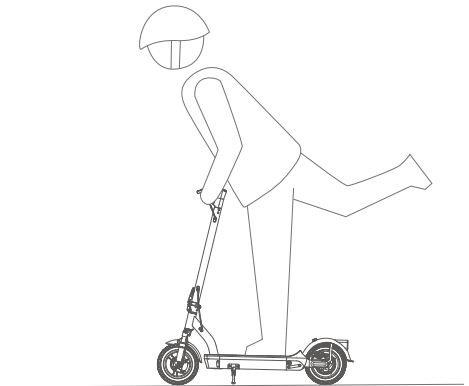

Preventing dangerous driving

It is forbidden to leave a scooter on a roadway for motor vehicles or ride in at a high speed

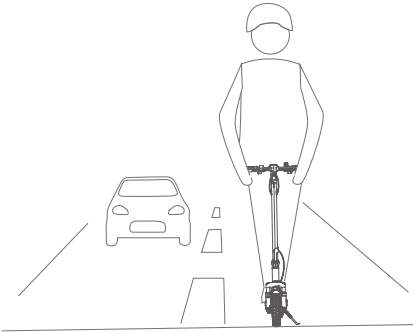

It is forbidden to sharply turn a residential area with a large flow of passers-by

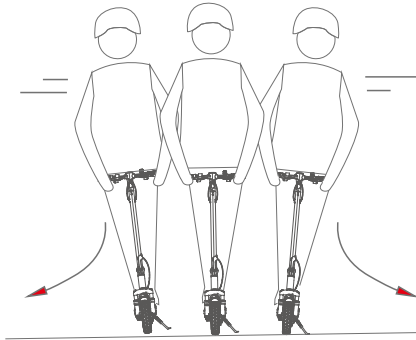

It is forbidden to drive through puddles, to which exceeds depth of 2cm.



Never rider a scooter more than or one person,hold a child in your arms.

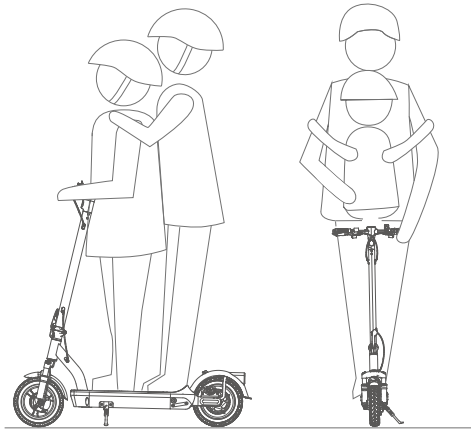

Do not tread the back of the fender



Do not touch the disc brake

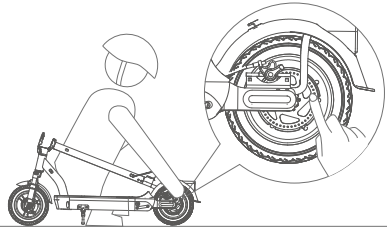

Do not driving leaving your hands



Do not riding electric scooter up, down steps or jump over obstacles

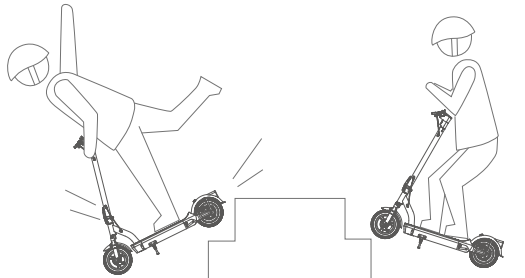

Safety Recommendations

- 1) Electric scooter - it is only a device for entertainment, not vehicle. But once you driving to public area, the electric scooter brings certain risks for your safety. For the sake of your safety and others safety, you must strictly follow the instructions, outlined in this driving manual.
- 2) You should understand that if you ride a scooter in a public place, you must comply with all recommendations for safety. Also do not forget that there is a possibility of collision, due to violation of pedestrians or vehicles traffic rules, there is also a risk of injury, due to improper operation of the unit. As in other types of vehicles, the higher a speed of electric scooter, the greater a braking distance. On some smooth road emergency braking may cause skidding of scooter, loss of balance and even fall. Therefore, during moving of scooter you need to be vigilant, to adhere to an appropriate speed, keep a safe distance from pedestrians and / or with other vehicles. Riding on unfamiliar terrain, keep vigilance and appropriate speed.
- 3) While riding scooter, respect rights of pedestrians. Do not scare them, especially children. Reduce speed, passing by them. If you are moving in the same direction with pedestrians, try to stick to the left side as much as possible (for right-hand traffic countries). If you are moving in the opposite direction, stick to the right and slow down.
- 4) Please strictly follow your country road rules to driving, and also strictly abide by rules, set out in the instructions and safety recommendations. Violation of the above rules may result in financial expenses, personal injury, occurrence of traffic accidents, legal disputes, conflict and other unpleasant situations. Our company does not bear any direct or joint and several liability.
- 5) To avoid personal injury, do not loan electric scooter to others whom do not know how to drive. Please spend a training before you transfer your scooter to friends, as well as teach he (her) must wear the proper safety gear.
- 6) Please do inspect scooter carefully before each use. If you find shattered parts, battery life has decreased obviously, tires leak air or there are signs of excessive wear, uncharacteristic sounds when turning or other abnormal symptoms, please discontinue use of the scooter immediately, don't drive it reluctantly.

7. Fold and Transportation

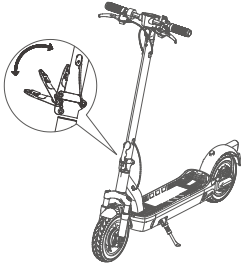

Fold

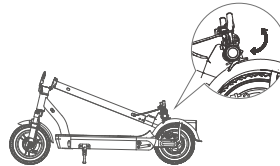

Make sure scooter be off, hold the front pole, loosen a lock lever and lower a steering rack. Adding a steering rack in a horizontal position and secure it by inserting a hook through a special ring , which is located on the rear wheel mudguard . To Assemble the scooter ,disconnect a steering rack lock from a hook of a mudguard , and then lift it into a vertical position and lock a lever.

Transportation

You can transfer folded scooter with one hand

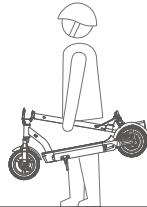

8. Maintenance and Storage

Clean and store Electric Scooter

If you find any stains on electric scooter housing, use a soft, damp cloth to wipe the vehicle. You can use toothpaste and a toothbrush to clean the scooter from stains, and then wipe it clean with a damp cloth. If you find scratched on parts, made of plastic, use sandpaper or other grinding materials for their polishing.

Warning: Do not use alcohol, petrol, kerosene or other corrosive solutions , volatile chemical solvents to clean the vehicle. Otherwise, it will cause serious damage to the scooter body and can disrupt a structure of internal elements. Do not wash electric scooter under a strong pressure of the water, make sure the scooter in the off status. In addition, after charging of the vehicle, it is necessary to insert a plug back to a charging connector, otherwise you may get an electric shock, or may have serious water damage cause from water falling into this hole, may have serious water damage.

If you do not use the scooter ,store it in a dry ,cool place and do not leave the unit for a long time on the street. Leaving the device under the sun/in extremely high temperature/over-low temperature can cause rapid aging of an outer body and wheels of Electric Scooter or reduce battery life.

Maintenance of Electric Scooter battery

- 1) Do not use batteries from other brands in order to avoid a dangerous situation;
- 2) Do not open or disassemble the battery to prevent electric shock. Avoid contact with metal objects to prevent an occurrence of a short circuit. Otherwise, the battery may have malfunction or can injure the user;
- 3) It is recommended to use an AC adapter, that comes in original configuration of the device, to prevent an occurrence of an accident or fire of the vehicle;

4) Improper disposal of used batteries and accumulators is the cause of severe environmental pollution. Please, dispose of batteries in accordance with local laws. Please do not dispose of batteries together with food waste. Protecting the environment together!

5) After each use of the device, charge the battery to prolong its service life.

Do not store the scooter battery in rooms with temperatures, that exceed 50 °C or -20 °C (for example, do not leave the battery of Electric Scooter and other batteries in cars in summer time on the hot sun), do not leave the battery near fire. As a result of these actions may deteriorate the battery, overheating and can even cause inflammation. If within 30 days the scooter is not used, charge the battery and keep the device in a cool, dry place. Every 60 days you need to charge the battery, otherwise there is the likelihood of its failure, which is not subject to warranty services.

Avoid a full discharge of the device, it will to extend battery life. When using the device at normal room temperature, the battery will be able to ride much greater distance and its performance will be better; but if you use the scooter at temperatures below 0°C, vehicle performance and permeability decrease.

At -20°C a traveled distance is less, than the scooter in the normal conditions of half or even less. If a temperature rises, a traveled distance by the vehicle will also increase. You can check remaining distance in the Application.

Note: A fully charge scooter runs about 120-180 days of standby time. The battery has a smart chip, that stores information about its charging-discharging. If you are not charging the battery for a long time, it can cause serious damage, for which it is impossible to charge the device again. This kind of damage is not included in free warranty service. (Caution: Do not disassemble the device by unauthorized people, as there is a risk of electric shock or serious injury as result of a short circuit.

Adjusting a brake disc

If a brake is very tight:using M6 hex wrench and scroll counterclockwise screws of brake disc tensioner pulley,slightly shorten a length of a tail brake cable,then tighten a tensioner pulley.If you think that brake is very free,loosen a tension pulley,pull a brake cable to slightly increase a length of its tail.Tighten a tension pulley.

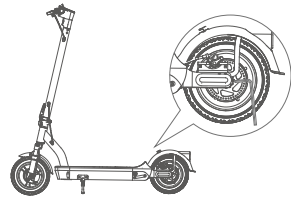
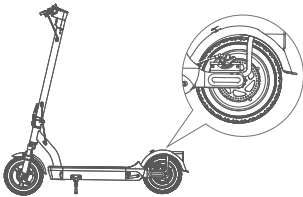

Adjusting a brake disc bars

Staggering of steering rack:using a M6 hex wrtench,tighten two screws near the folding mechanism

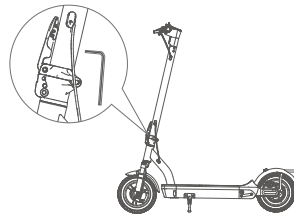
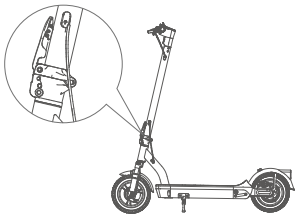

9. Parameters

Operating parameters	Name	H11
Dimensions	Length x Width x Height[1] (cm)	121*49*129
	Folded:Length x Width x Height(cm)	121*49*56
Weight	Net weight	22.9kg
Conditions	Max load	120kg
	Recommended Age	16-50
	Height(cm)	130-200
Main Parameters	Possibility in average condition [2] (km)	45
	Maximum slope(%)	20
	Operating temperature range(C)	-10-40
	Temperature of storage(C)	-20-45
Battery Parameters	Battery Input voltage	36V
	Battery capacity	15AH
Motor Parameters	Rated power(W)	500W
Power Adaptor Parameters	Rated input voltage(VAC)	100-240V
	Rated output voltage(VDC)	42V
	Rated current(A)	2A
	Charging time(h)	Est.6