

X11

Long battery life off-road E-SCOOTER

- 50km Long-life lithium batteries
- 450W motor drive



X11 pays tribute to the classic X8 upgrade





The freedom of choice

New design, new development, full-stack self-developed



450w

Max output power



10inch

2.7 Ultra wide tubeless tire

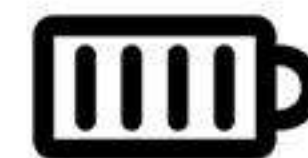

50km

Long battery life



3s

Rear wheel quick release



2Places

Spring suspension



3s

Quick fold



Controller

Elbow for quick release



1Body

Aluminum alloy frame



175mm

Pedal width

Comprehensive upgrade Long battery life

Embedded removable battery, adding quick release.
Locking screw design, better fix the battery
Not loose.

50_{km}

Long battery life

13_{Ah}

Lithium battery

*Tips: Actual battery life may vary due to factors such as load, temperature, wind speed, road surface and operating habits.

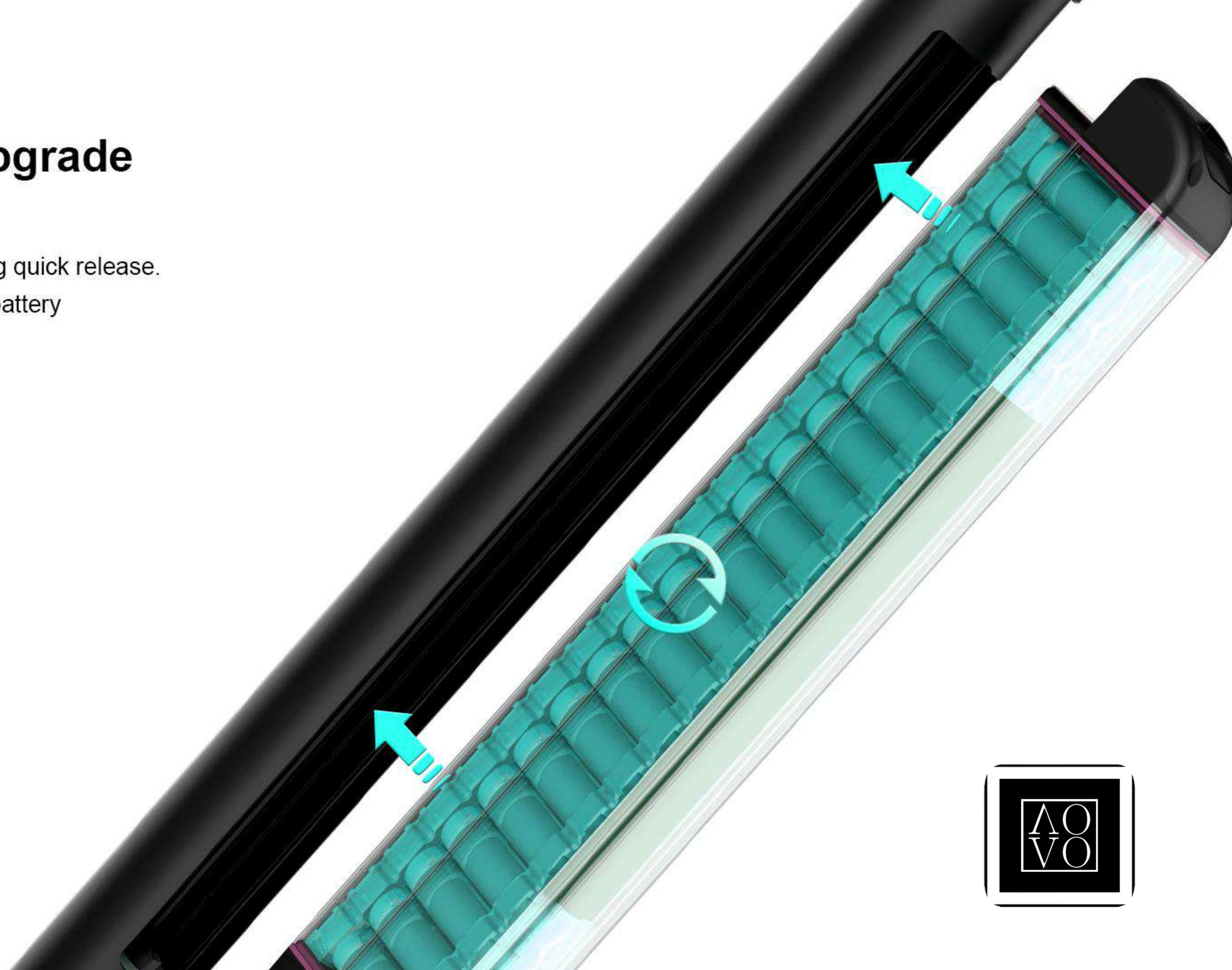

13Ah

Automotive-grade power lithium battery

6 large battery intelligent protection

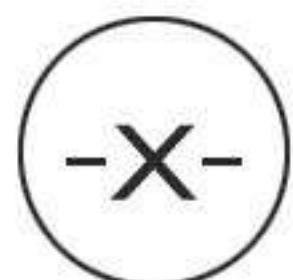

Short-circuit
protection

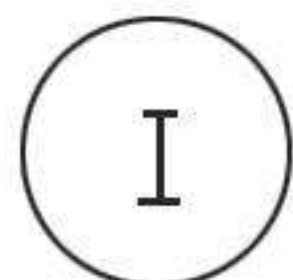

over-current
protection

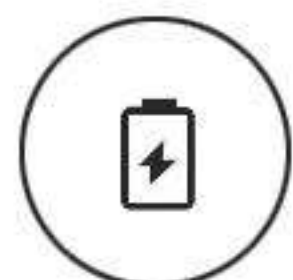

double over-
charging protection



double over-
output protection



Abnormal
temperature protection

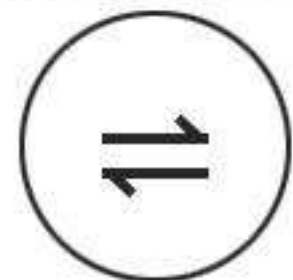

under-voltage
sleep automatically

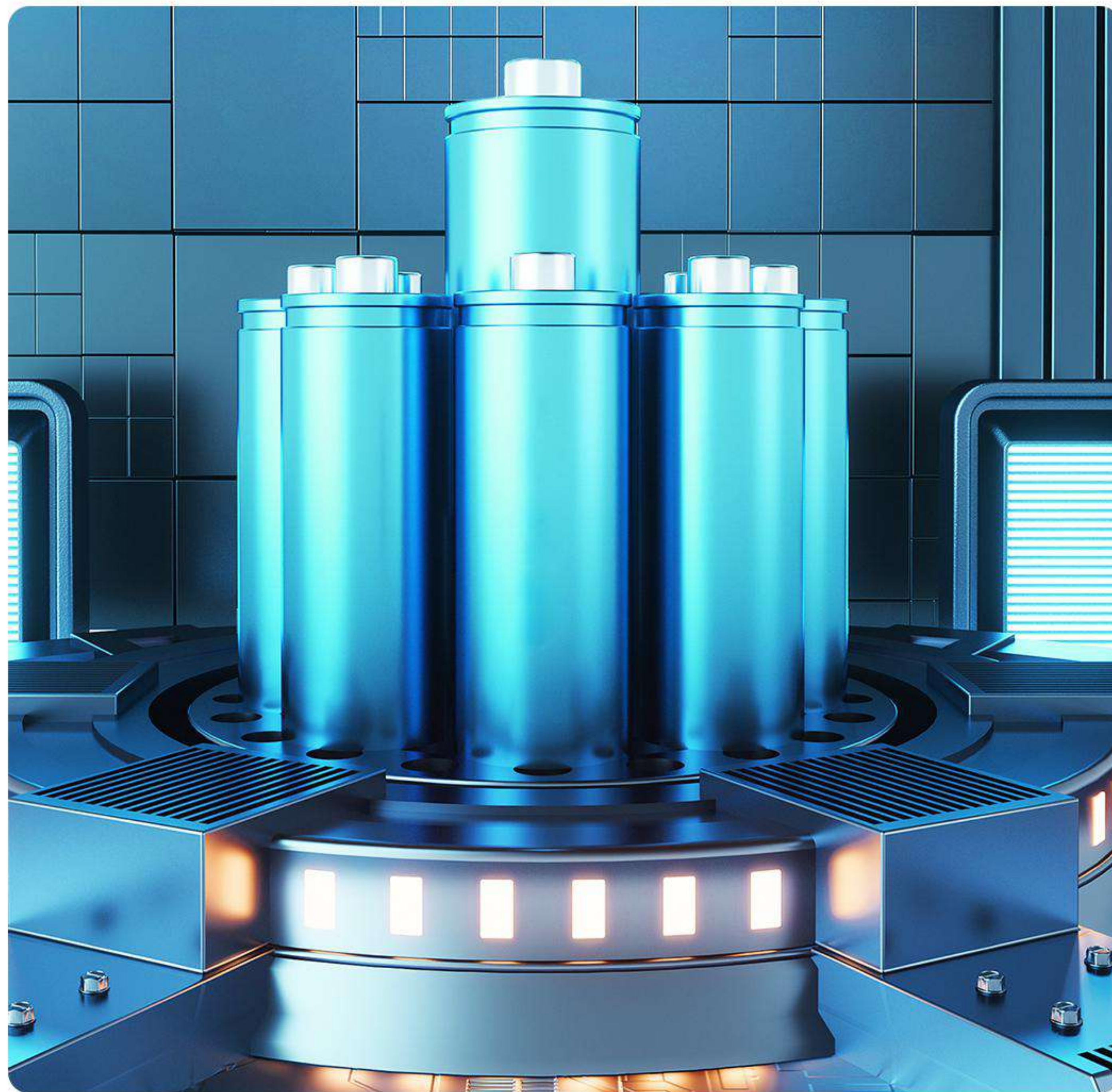

Brand new design

U-shaped suspension pedals

Soft lines, smooth body, Create a sense of dynamism
ready to go, Strong aluminum alloy lightweight frame,
Wear-resistant and compression-resistant.



15kg

Max speed

100kg

Max weight

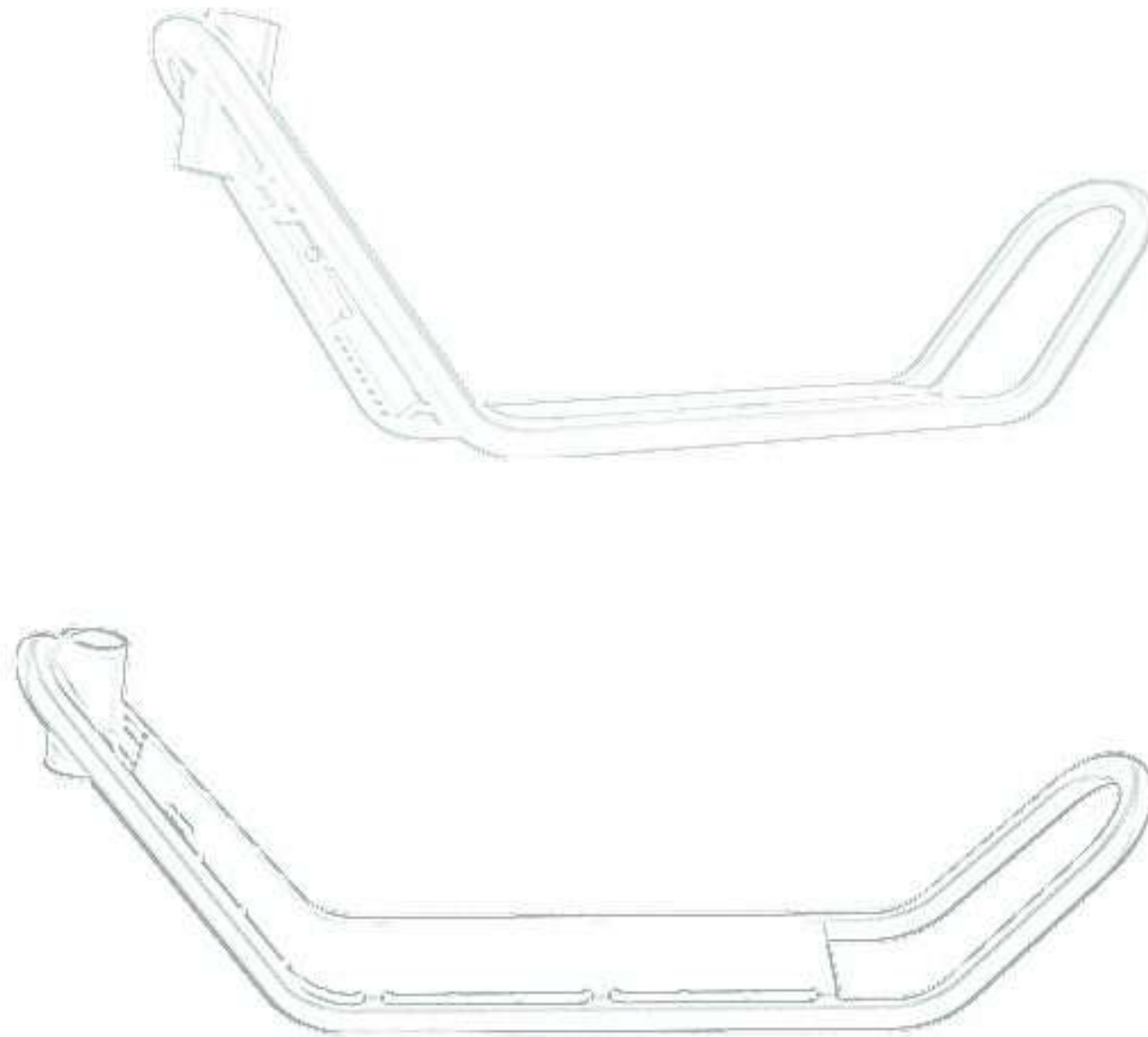

New development Dual spring suspension system

The chassis is high, and the pedal height is 16cm from the ground. Spring suspension on both sides of the front fork. Comfortable and fun to ride, suitable for all kinds of roads.

16cm

Ground clearance of pedal

IP54

Waterproof grade

Spring suspension on
both sides of the front fork



The new upgrade High-speed brushless power motor

10 Inch 2.7 Ultra wide road tubeless tire.
Anti-skid, anti-puncture, explosion-proof,
wear-resistant.

10inch
Tire size

450W
Power motor



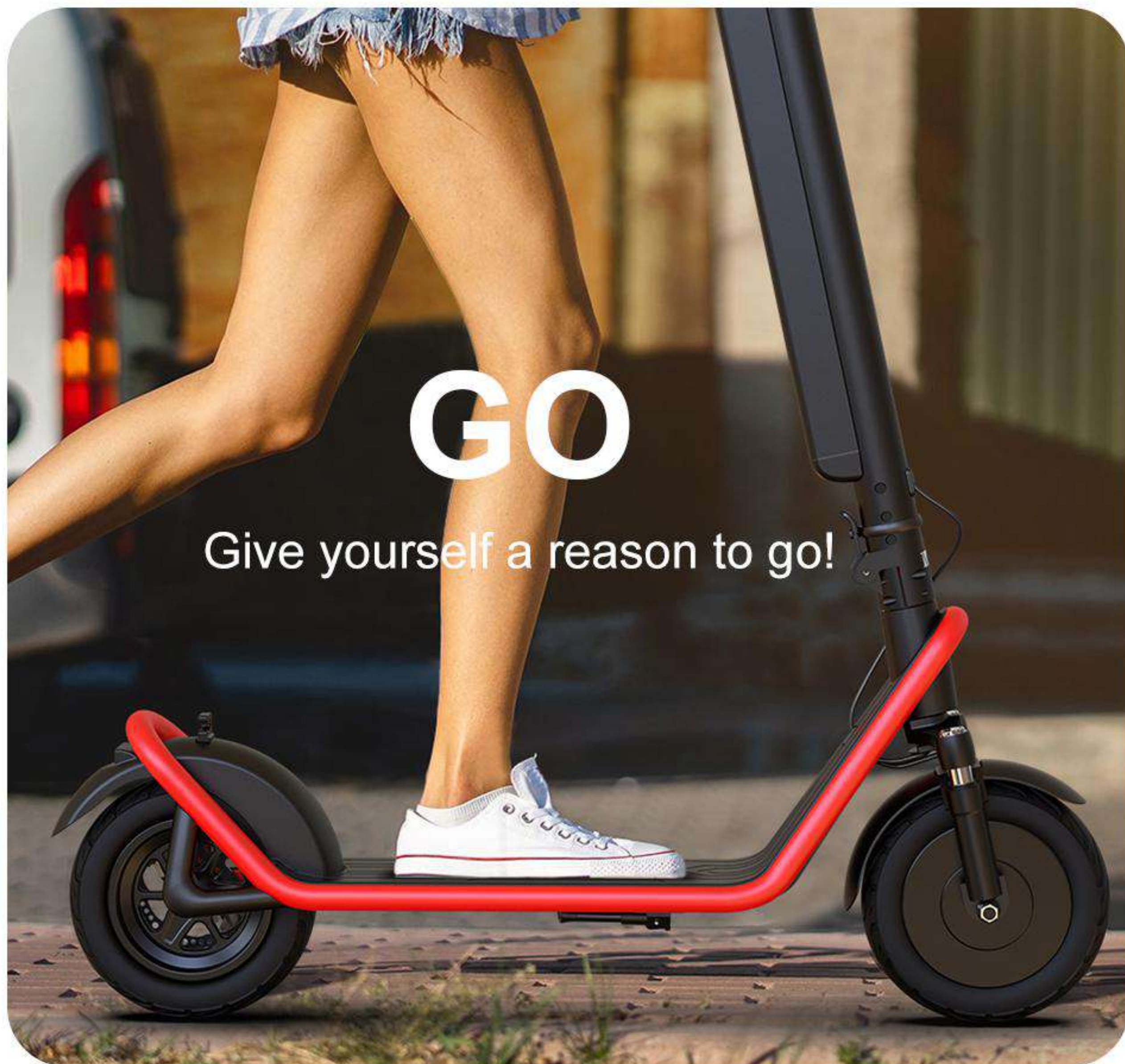

GO

Give yourself a reason to go!

WC Controller adds spring device

The controller is mounted on the elbow for quick release



Add springs on the brake terminals to reduce battery looseness.

The controller is mounted on the elbow for quick release.



No worries after sale Rear wheel quick release

3 seconds quick disassembly and replacement, turn the screw. Easy to replace, reducing the difficulty of after-sales.



3 s quick disassembly and replacement,

Hard strengthening Integral design of rear fender

The rear fender adopts a one-piece design,
with few parts for easy maintenance.
Enhanced performance security.



X11

Pedal width: 175mm

175mm
Pedal width



X8

Pedal width: 145mm

Rear fender
Overall design with
fewer parts, easy
maintenance.

Rear fender
Brakeable
more parts

Full stack self-developed LED large screen display

Multi-function dynamic real-time visibility, accurate display of speed, power, gear switching, etc., preview your car at any time.



Push-to-accelerate shifter design

Waterproof dial design, one touch to accelerate.
Long press the accelerator for more than
6 seconds to cruise.

Classic retention LED night lighting system

Super bright headlights, the driving environment on the road ahead is unobstructed, and the illumination distance is long, ensuring the safety of riding at night.



Tail warning light

Safety flashing warning light, light when braking
Lighting is clearly visible even from a distance.



Innovative design

3 Seconds quick fold rotary clasp

One turn, one click, one buckle, minimalist ring-type folding buckle design, small storage space, and can be easily lifted with one hand.

3_s

Quick fold

1130_{mm}

E-scooter width



Hand held



In the elevator



Trunk

Safe braking Efficient and stable braking performance

Equipped with ventilated disc brake system

E-ABS anti-lock braking system.

Efficient braking and quick response.

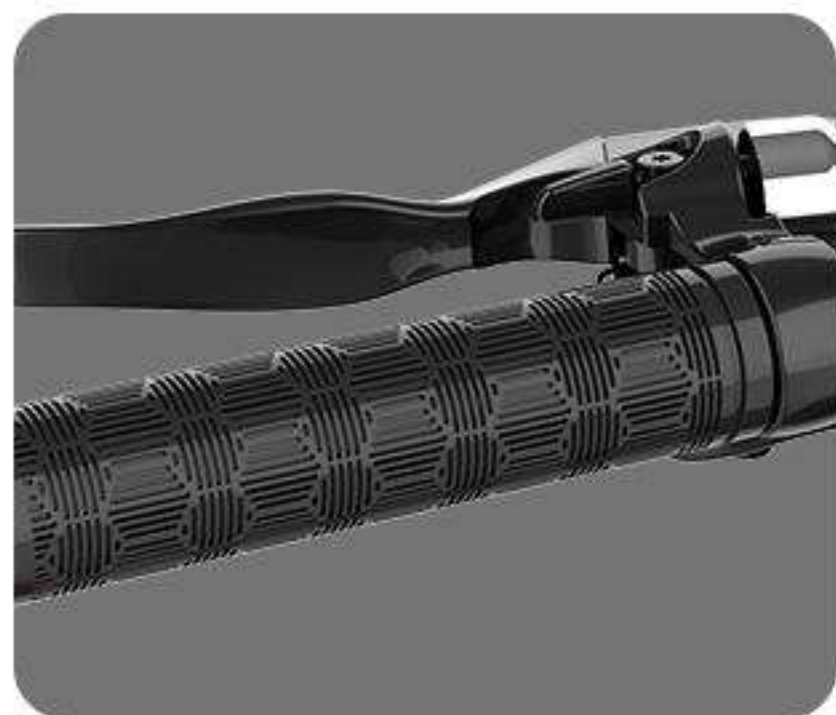

Electronic brake



Rear mechanical disc brake





Open size:1130x410x1260mm



Folding size:1130x410x550mm

Model	X11 Long battery life off-road e-scooter
Open Size	1130*410*1260mm
Fold Size	1130*410*550mm
Net Weight	14kg
Frame Material	Aluminum alloy
Tire Size	10 inch
Max Range	40-50km
Speed	25km/h
Rated power	36V/450W
Climbing Angel	20°
Pedal Width	175mm
Ground Clearance of Pedal	160mm
Ground clearance of pedal chassis	135mm
Folding method	3 Seconds quick folding
Battery capacity	13Ah Li-ion battery
Charger parameters	DC42V/2A
Motor driven	Rear wheel drive
Battery removal method	Portable and removable
Waterproof level	IPX4
Charging time	5-7hours
headlight	LED high-brightness front light
taillight	Rear LED
Applicable height	120~200cm
Load range	100kg
Input voltage	100-240Vac 50/60Hz